

An Ensemble of Surround Physics

[Volume-3]

(A collection of awarded Essays in NCEWP – 2023)

PHYSICS IN FORENSIC SCIENCE

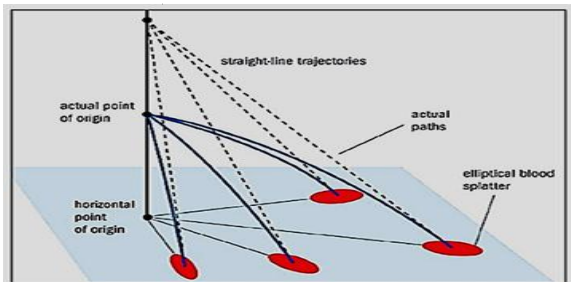

Representation of blood spatter analysis



Glass Fractures hit by a bullet

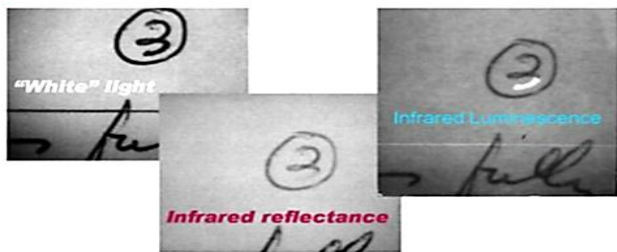

Case of altered medical record

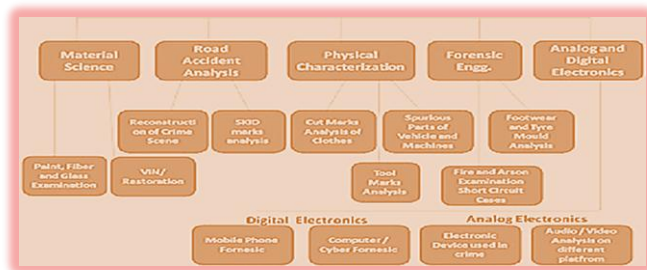

Branches of Forensic physics

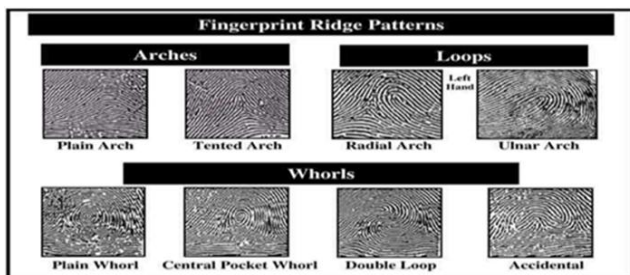

Fingerprint Ridge Patterns

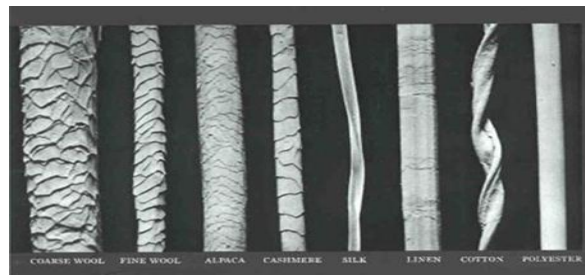

Comparison of Fibers by Microscopy



SEM image of human hair

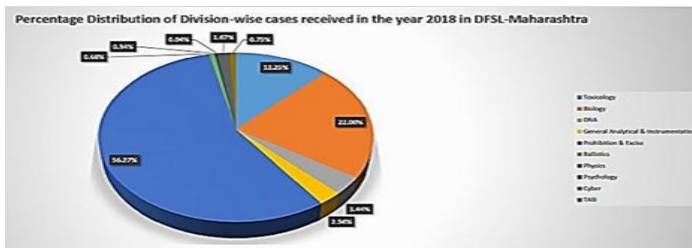

Percentage distribution of division-wise cases received in 2018 in DFSL-Maharashtra

CELEBRATING THE 40TH YEAR OF IAPT

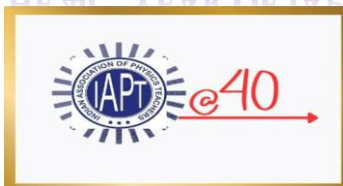

Thinking about IAPT means Thinking about how so many physicists are working so hard to realize the dreams of Professor Khandelwal
Prof. Ajoy Ghatak

Foreword

It is a pleasure to see 3rd volume of *Ensemble of Surround Physics*, a collection of awarded essays of IAPT National Competition as an e-book. It has been very satisfying to see a rise in number of participants both in the students and teachers' categories this year. Timely announcement of competition right in the beginning of the year helped reach the message to a wider audience. Conducting this kind of competition poses lots of challenges to both the participants and the organizers. Regional Councils of IAPT organized competitions at their own level and sent best three entries from their regions for the final round. They deserve applause for taking this competition to IAPT's two most important stake holders: physics students and physics teachers.

Such competitions are in tune with the development of attributes of a graduate of a school, college and university as envisaged in the implementation documents of National Education Policy 2020, which is in the third year of its implementation. Such essays help in blossoming hidden talents of students and providing them an opportunity to discover their skills needed for their future roles in STEM.

This year's topic was *Physics in Forensic Science*. Essays beautifully bring out the influence physics has in the area of forensic science, a truly multidisciplinary field of scientific study, with application of very simple physics principles drawn from mechanics, to the state-of-the-art equipment's using Raman spectroscopy, scanning electron microscopy, digital device analysis techniques and so on. Each essay brings out one aspect or the other of the physics at the forefront in the service of forensic scientists.

One very instructive role these essays play is in bringing out areas in which students trained in physics with a research mind can find a wonderful career to put science at the service of society. Here science acts in the hands of an expert forensic expert an irrefutable tool for collecting evidences for almost shut cases in the history of crimes across the world, leading to the prosecution of criminals adept in masking their criminal footprints. In the present era of digitization, criminals committing crime can hide his/her identity in the labyrinths of billions and billions of terabytes.

I wish if we also ask the participants to give a suitable title to their essays, to unfold for a reader, at a first glance, what aspect of the topic the writer is touching in the broad field given as a topic to explore.

Team led by Prof. S.K. Joshi has done a commendable job to invite essays, getting each essay vetted by a dedicated team of experts, ranking these for awarding prizes and finally culminating in this beautifully edited e-book of essays. Congratulations to the participants and winners. Main goal of this competition of essay writing is to let the participants pass through a process of research, discovery and presenting their material in a coherent manner as a scientific write up for their own learning and for leading the readers to new knowledge which is growing exponentially with each passing day.

Congratulations once again to the winners, participants and team NCEWP on behalf of IAPT community. Well done all. Good luck for your future endeavors.



PK Ahluwalia

President Indian Association of Physics Teachers

Preface

Writing makes one perfect and writing an essay even more so....

National Competition on Essay Writing in Physics (NCEWP) is one of the three national competitions held by IAPT every year. The competition is open to participants in two categories, viz., students and teachers (including Science Communicators).

Category A – Students of Higher Secondary /Jr. College, UG and PG levels;

Category B – Teachers of Higher Secondary/Jr. College, UG and PG institutions, also Science Communicators working in recognized institutions.

Since 2019, due to the Covid Pandemic, NCEWP was conducted by submitting the essays through Email. Subsequently, an idea of e-Book containing the collection of selected essays was given by our President IAPT Prof. P. K. Ahluwalia. I am extremely thankful to our President for this novel suggestion.

On 25th September 2022, we uploaded the **first Volume of e-Book** containing the awarded essays from the year 2019 to 2021 on IAPT Website. Further, on 25th February, 2023 **Volume-2** of the awarded essays for the year 2022 was uploaded on IAPT Website. Now, this most recent **Volume-3** includes 14 essays on the topic **“PHYSICS IN FORENSIC SCIENCE”**. This year 93 essays were received; it is the highest figure since the starting year 2012 of competition.

The essays were evaluated by three experts and aggregate marks were considered towards the final results. All entries were checked for plagiarism by me. Negative marks were assigned by the evaluators for copy-paste instances. We are very much thankful to the expert evaluators Dr. D. A. Deshpande, Dr. Mihir Pal, Dr. Sapna Sharma, Dr. Swapan Majumdar, Dr. A. P. Deshpande and Dr. Usha Singh for their voluntary services in this competition.

Many IAPT members helped in getting essay entries from their regions: I am especially thankful to Dr. Seema Vats, Dr. Hemant Kumar, Dr. Sunder Singh, Dr. Vijay Kumar, Prof. Y. K. Vijay, Dr. Pruthul Desai, Dr. Viresh Thakkar, Dr. Ranjita Deka, Dr. Runima Baishya, Dr. Pradipta Panchadhyayee and Dr. Mitesh Chakraborty.

I am extremely thankful to our President Prof. P. K. Ahluwalia and General Secretary Prof. Rekha Ghorpade. I sincerely thank all EC Members, Office bearers of RCs, all Vice Presidents IAPT, Prof. B. P. Tyagi, Prof. U. S. Kushwaha and Prof. Manjit Kaur. Apart from this, I am also thankful to my committee members Dr. Himanshu Pandey and Dr. Shivanand Masti for their help. Thanks to Kanpur Office: Dr. Sanjay Sharma, Dr. D. C. Gupta and Vinod ji for their excellent help in the Prize Distribution Ceremony. Finally, I am thankful to all the participants of Essay competition and those who helped me in conducting this event directly or indirectly.

As an editor, I have only tried to rectify language errors and made the formatting more consistent. The basic content of the essays has been kept as it is. In the end, I am very much thankful to Sambodhi Translation Services, Indore for their professional services in getting this e-book (Volume-3) out in the current shape. In the last part of this e-book, the Guidelines for Essay Writing and Developing Skills for Science Communication have been included as an Appendix.



S K Joshi
Coordinator NCEWP & Editor of e-Book

Table of Contents

Sr. No.	Rank	STUDENT'S CATEGORY (A)	Page No.
		Year 2023	
		PHYSICS IN FORENSIC SCIENCE	
		Name and Institution	
1	First	Anmol Setia , Department of Physics, Punjab University, Chandigarh	1
2	Second	Aditya Kumar , Ramjas College, Department of Physics & Astrophysics, University of Delhi	10
3	Third	Kavita Asawara , Department of Physics, IPS Academy, Indore	21
4	Third	Rahul Vishwakarma , Department of Physics, Marwari, College, Ranchi, Jharkhand	28
5	Incentive Award	Mizan Alvi , SMS Dutta Memorial Nosegay Public School, Khatima, Udham Singh Nagar, Uttarakhand	37
6	Incentive Award	Akshay Shankar , Calorx Olive International School, Ahmedabad	45
7	Incentive Award	Mannit Goyal , DAV Public School, BRS Nagar, Ludhiana, Punjab	55

Sr. No.	Rank	TEACHER'S CATEGORY (B)	Page No.
		Year 2023	
		PHYSICS IN FORENSIC SCIENCE	
		Name and Institution	
1	First	D. Usharani , Department of Physics MES College of Arts, Commerce and Science, Bangalore	63
2	Second	Mahendra M Khandpekar , Department of Physics, B K Birla College, Kalyan	73
3	Second	V K Gupta , Department of Physics, Govt. Girls PG College, Ujjain	81
4	Third	Karishma Sharma , TGT-Physics, Shiv Nadar School, Noida	91
5	Incentive Award	R. Venkatesh , Department of Physics, PSNA College of Engineering and Technology, Kothandaraman Nagar, Dindigul Tamilnadu,	102
6	Incentive Award	Sonika Jindal , DAV Public School, BRS Nagar, Ludhiana, Punjab	112
7	Incentive Award	Gajanan Patil , Secondary School & Jr. College, Bhilawadi, Maharashtra	124
		Appendix	133

Continued.....

PHYSICS IN FORENSIC SCIENCE

Anmol Setia

Department of Physics, Punjab University, Chandigarh

Key words: Physics, Crime scene reconstruction, Analysis of evidence, Aid in Justice, Instruments.

I am very sure that at some point in your life, you must have seen an episode of crime investigation serials on television where a person, professionally a forensic expert, conducts an investigation and tells a lot of details about the crime which helps a lot in finding out the real culprit behind the crime. I, being a Physics enthusiast, always wondered what tools and techniques do this forensic scientist used so that he is able to figure out these minute details with such precision. If you also have a similar question, let's put an end to it today.

Forensic science is a field that uses various scientific principles and methodologies to investigate crimes and provide evidence. Among the various disciplines contributing to forensic investigations, physics plays a crucial role. Physics, the study of the Universe, provides valuable tools and techniques for analyzing and reconstructing crime scenes, identifying causes of injuries, examining ballistic evidence and various other purposes.

Easy physics, subtle applications

Let's go back into the time a little bit, a young woman was found dead at the bottom of a cliff in Sydney, Australia, in June 1995. The site was a popular suicide spot and the police assumed that she had killed herself. But in November 2008 the woman's boyfriend was convicted of murder. "It took more than 10 years to figure out that the woman was thrown off the cliff; she did not jump," says Dr. Rod Cross, a physicist at the University of Sydney who served as a consultant for the case. It took that long, he adds, "mainly because the police did not understand that physics could help solve the problem."

– Toni Feder

- **Crime Scene Reconstruction**

It is a very crucial aspect of forensic investigations and physics lays down the foundation for it. By employing principles of collision, trajectory analysis, and Newton's laws, experts can determine the sequence of events leading to a crime and establish crucial information for reconstructing the incident such as determining the point of impact, speed of objects or individuals, the direction of force applied and various other important information. One example of this is the analysis of vehicular accidents. By examining the physical evidence at the scene, such as tire marks, vehicle damage and debris patterns, forensic physicists can reconstruct the collision and determine the speed, direction of the vehicles involved and can calculate the forces acting on the occupants, providing insights into the injuries.

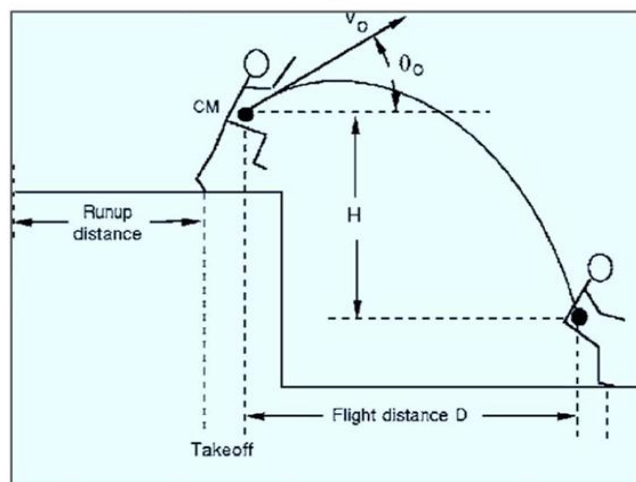

Figure 1: Diagram of Crime Scene Reconstruction using Kinematics

Like with the skid marks of a car, which help us in determining the speed of the car. It can be calculated with the formula:

$$S = \sqrt{30 \times d \times f}$$

Where S is the speed of the car (in mph), d is the distance the car skidded (in feet), and f is the coefficient of friction.

Another example is the analysis of gunshot wounds. By studying the trajectories of bullets, the nature of the wounds, and the properties of the weapons involved, forensic physicists can calculate the angle of the shot and the distance between the shooter and the victim.

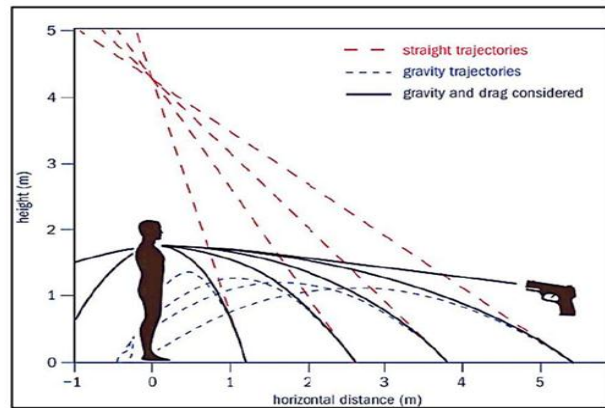

Figure 2: Studying Bullet Trajectories

- **Bloodstain Pattern Analysis**

Physics plays an important role in bloodstain pattern analysis. By studying the physics of fluid dynamics, experts can analyze blood spatter patterns to determine the nature of a crime. Principles such as the impact angle, surface tension, and the behavior of droplets allow analysts to interpret bloodstains and deduce crucial information regarding the location of the assailant, the type of weapon used, or the positioning of victims and perpetrators during the crime.

One example of bloodstain pattern analysis is the interpretation of spatter patterns resulting from blunt force trauma. By analyzing the size, shape, and distribution of bloodstains, forensic physicists can deduce the type of object used and the force applied, providing information about the nature of the assault. Have a look at the picture below for better understanding.

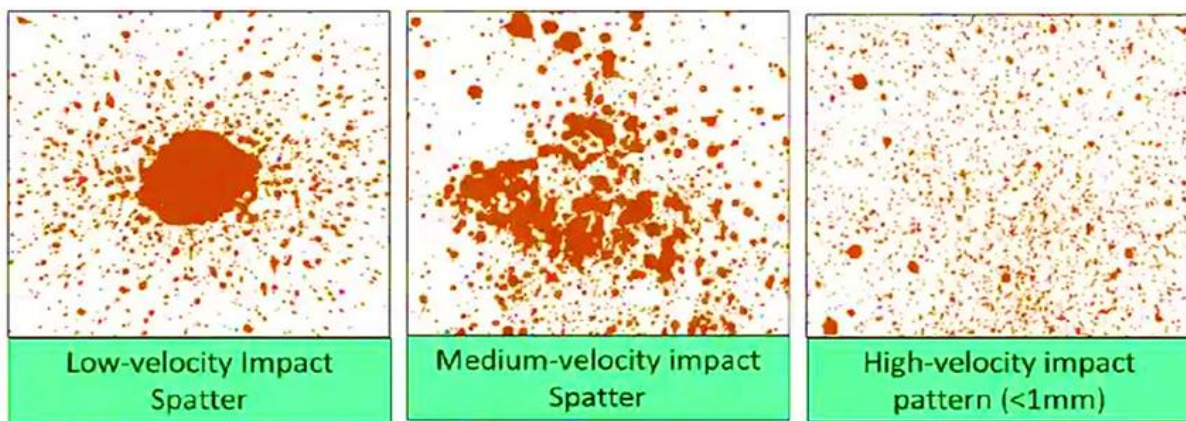

Figure-3: Blood Patterns in Different Velocities

- **Ballistics and Firearms Analysis**

The field of ballistics relies heavily on principles of physics to analyses firearms, ammunition, and the behavior of projectiles. By considering factors like bullet trajectory, muzzle velocity, and the properties of various materials involved, forensic experts can match recovered bullets and cartridge cases to specific firearms, and provide valuable insights into the mechanics of a crime. Physics-based tools like firearm examination, gunshot residue testing, and bullet trajectory analysis aid in connecting

weapons, suspects, and crime scenes.

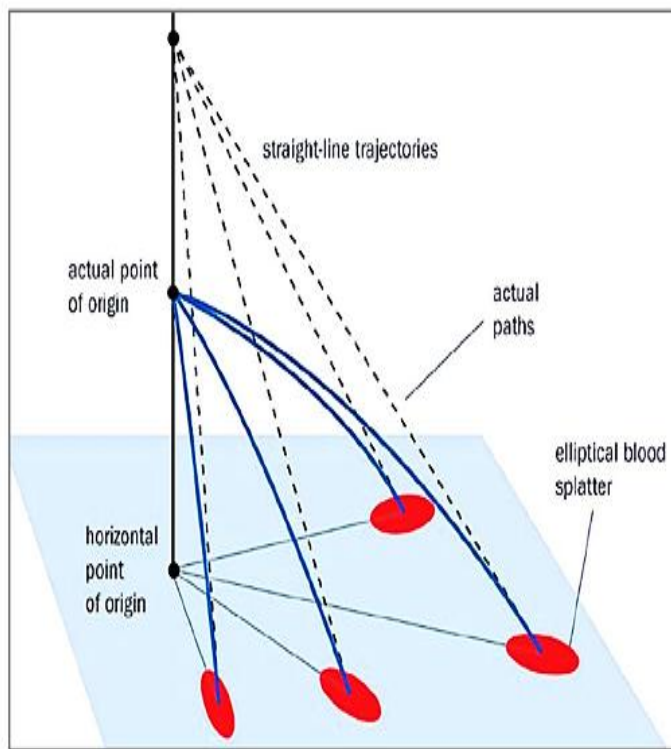

Figure-4: Representation of blood spatter analysis

By studying the trajectory of a bullet, forensic physicists can determine the angle of the shot, the distance between the shooter and the victim, and the location of the shooter. This information is crucial in reconstructing the sequence of events. Additionally, the physics of firearms and ammunition plays a significant role in forensic investigations.

By analyzing the properties of bullets, such as their size, shape, and composition, forensic physicists can identify the type of firearm used. The study of ballistics also involves analysing the muzzle velocity, which is the speed at which a bullet leaves the barrel of a firearm. By calculating it, experts can estimate the range of a shot.

Furthermore, forensic physicists use gunshot residue (GSR) analysis by Electron Microscope to provide evidence of a suspect's involvement in a shooting. GSR consists of microscopic particles that are discharged from a firearm upon firing. Here, electron microscopy assists in identifying unique characteristics and patterns that can link a particular weapon or tool to a crime. By analyzing the distribution and composition of GSR particles on the hands or clothing of individuals, forensic scientists can determine if they were in close proximity to a fired weapon.

- **Digital Forensics**

Digital forensics involves the recovery and analysis of electronic evidence. Physics principles underlay in the functioning of electronic devices, storage media, and data transmission. Concepts like magnetic fields, data recovery, and encryption are crucial for extracting evidence from digital devices. Understanding the physics behind data storage and transmission allows forensic analysts to recover deleted or encrypted files, trace digital footprints, and reconstruct timelines of digital activities.

Forensic physicists employ techniques such as magnetic field imaging to recover data from damaged storage media. Every data that is stored has its unique magnetic field and by using sensitive magnetic sensors, physicists can detect and interpret those magnetic fields, reconstructing lost or deleted information. This is particularly useful in cases where criminals attempt to destroy digital evidence.



Figure 5: Chart of process of Digital Forensics

- **Trace Evidence Analysis**

Physics assists in the analysis of trace evidence found at crime scenes, such as fibers, hair, glass, etc. Spectroscopy, microscopy, and other physics-based techniques enable forensic scientists to identify and compare these minute materials. By examining their optical properties, elemental composition, or refractive indices, forensic physicists can link evidence to specific sources and reconstruct events. Understanding the physics of light interaction with materials aids in identifying and characterizing trace evidence, providing valuable information in criminal investigations.

Similarly, the analysis of glass fragments involves the use of physics-based techniques. By examining the refractive indices, crystal structure, and elemental composition of glass fragments, forensic physicists can match these fragments to specific sources.

The physics of light refraction and dispersion plays a crucial role in analyzing glass fragments under a microscope, allowing for the comparison and identification of glass types and the determination of whether the fragments originated from a common source.

In addition to the above areas, physics also plays a role in other branches of forensic science like anthropology utilizes physics-based techniques such as skeletal analysis to estimate the age, sex, stature, and ancestry of human remains. Principles of biomechanics and the mechanics of bone fractures aid in reconstructing the cause of injuries and determining the manner of death.

Instruments used in Forensic analysis

By now, we all might be clear with the fact that **physics plays a very crucial role in forensic science** but this detailed analysis of various things from microscopic analysis to advanced imaging methods and that with such a great accuracy and precision requires good instruments. Let's have a look at

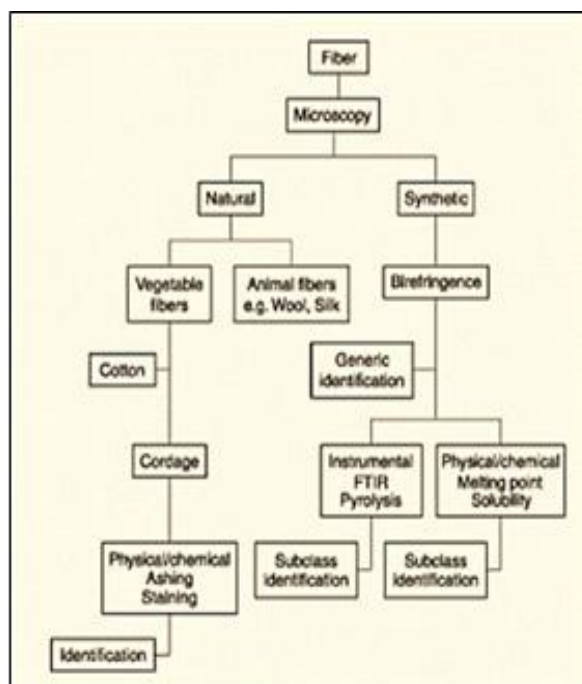

Figure 6: Chart of process of Fiber Analysis

some of those instruments and techniques.

- Microscope: It is one of the most crucial components of forensic investigations. Standard light microscopes allow forensic scientists to examine trace evidence, such as hair, fibers, paint chips, and glass fragments. Investigators can establish links between suspects and crime scenes by comparing samples with known references.
- Electron Microscope: Electron microscopes offer higher magnification and resolution than traditional light microscopes. They are used to examine minute details of evidence, such as tool marks, ballistic materials, and gunshot residue (GSR). They assist in identifying unique characteristics and patterns that can link a particular weapon or tool to a crime.
- Mass spectrometry: It is a powerful analytical technique used in forensic science for the identification and analysis of various substances present at a crime scene. Mass spectrometry aids in the detection of drugs, explosives, accelerants, and other chemicals crucial to criminal investigations.
- Photoluminescence phenomenon: It involves the emission of light by certain materials when exposed to specific wavelengths of light. This property is utilized in crime detection for the analysis of fluorescent dyes, fibers, and biological samples thus helping to establish connections

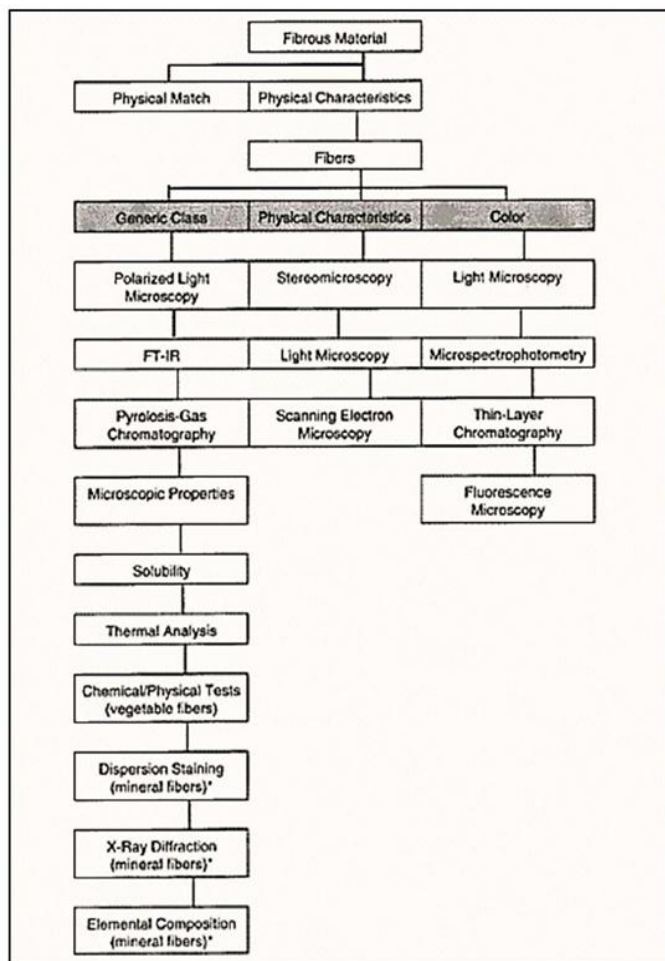
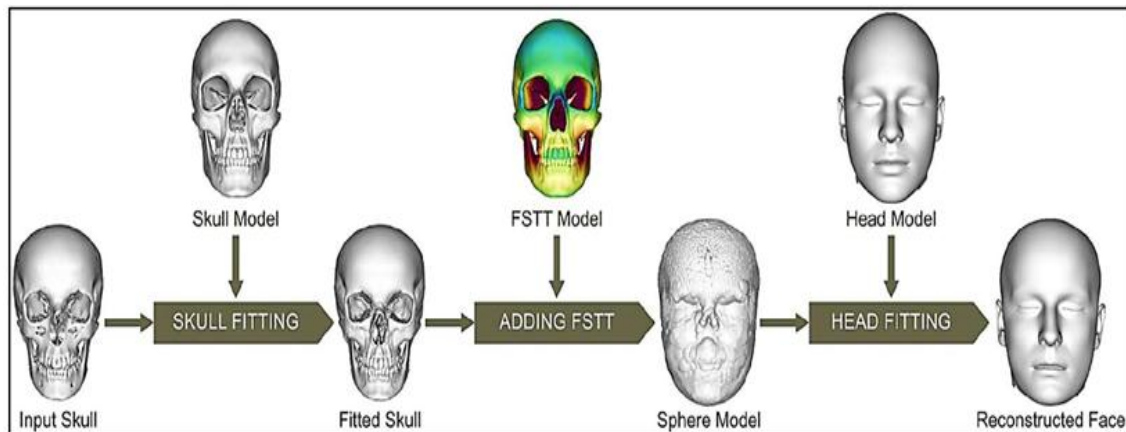

Figure 7: Chart of various techniques used to study materials

between suspects and crime scenes.

- Ultraviolet (UV) light: It finds extensive application in crime scene investigations due to its ability to reveal hidden evidence. UV lamps are used to detect bodily fluids (e.g., blood, semen, saliva) that may not be visible under normal lighting conditions. It can also unveil latent fingerprints and detect trace amounts of substances like accelerants and counterfeit currency.
- X-ray imaging techniques: X-ray diffraction and X-ray fluorescence, are valuable tools in forensic investigations. X-Rays can penetrate materials, revealing hidden structures, identifying counterfeit documents, and providing insights into the elemental composition of samples. X-ray fluorescence spectroscopy aids in identifying elements present in evidence, while X-ray diffraction helps determine the crystal structures of materials.

- **Software-based imaging methods:** Software such as facial reconstruction software, are used to generate facial images based on skeletal remains. By analyzing the bone structure and using anthropological data, it can create facial approximations that assist in identifying unknown individuals thus helping in reconstructing the appearance of the deceased.



- **Measurement of Density:** The measurement of density is crucial in forensic science to analyse various materials found at crime scenes. It is utilized in soil and glass examinations to compare samples from the crime scene with those from potential sources. By matching the densities of soil particles or glass fragments, investigators can establish links between a suspect and a specific location.
- **Refractive Index and Birefringence:** The refractive index is a property of materials that determines how light propagates through them. In forensic analysis, the refractive index is utilized for the examination of glass fragments. By measuring and comparing the refractive index of glass samples, investigators can determine if they originate from the same source. Birefringence is used for fiber analysis by matching them to potential sources or identifying unique characteristics.

Various types of crimes

So, by now we are also familiar with the various types of instruments and techniques used for forensic analysis but we must also be aware of crimes in which all these instruments and underlying physics work with such great accuracy and precision to deliver justice to everyone. Here are some of the notable types of crimes where physics-based techniques and instruments are applied:

1. **Road Accidents:** Physics principles, such as momentum, force, and collision analysis, help reconstruct road accidents and determine factors such as speed, impact, and the sequence of events.
2. **Fire and Burns:** Physics is employed in fire investigations to analyze fire patterns, determine the source and cause of ignition using techniques like mass spectrometry.
3. **Drowning in Water:** Underwater forensics utilizes physics to study buoyancy, hydrodynamics, and the behavior of bodies in water to determine the cause and circumstances of drowning incidents.

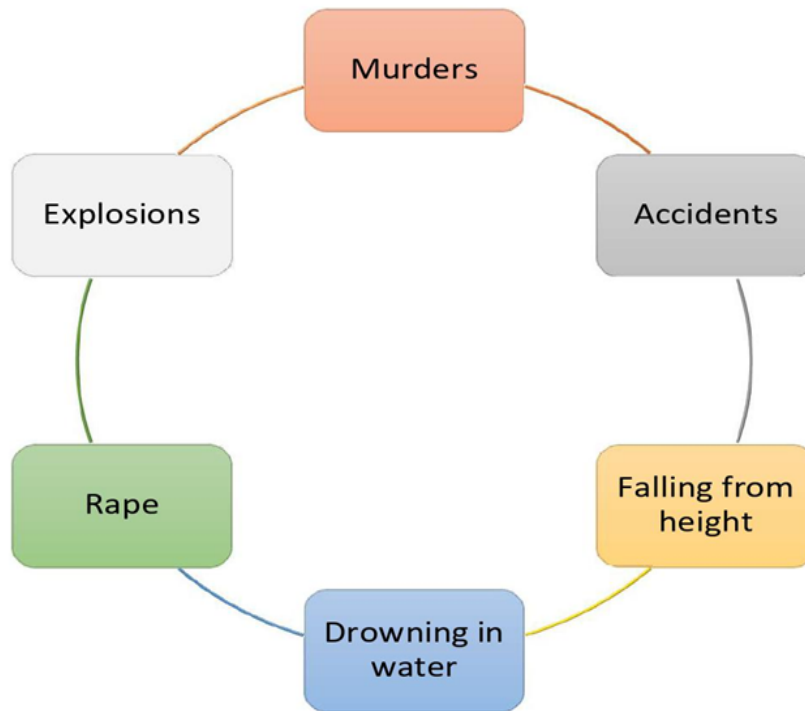

4. Falling from Height: Physics principles, including gravity, velocity, and impact analysis, assist in reconstructing falls from heights, thus providing crucial details for investigations.
5. Sudden Explosion/Blast: Physics-based techniques, such as blast pattern analysis and residue analysis using mass spectrometry, aid in determining the nature, and source of explosions.
6. Other Medico-Legal Cases: Physics-based techniques are utilized in various other medico-legal cases, including blood spatter analysis, DNA profiling, and forensic anthropology.

Crime in my City – CHANDIGARH

Chandigarh, a union territory in northern India, is known for its well-planned infrastructure and high standard of living, but it is not immune to crime. Just like any other city, it occasionally faces instances of violent crimes but it's relatively very low when compared to other metropolitan cities in India. A few of the crimes in which forensic analysis plays an important role are murders, rape, and road accidents. The Graph 1 below depicts the number of these crimes in the past 5 years. The data available on the website of Chandigarh Police was used to plot these figures.



You can see the numbers and get an idea about the growth rate of these crimes. You can notice that the growth rate for the last year has been negative. The credit for this significant reduction in the number of road accidents goes to the administration being very strict about traffic regulations and installing high-speed capture cameras at almost all traffic lights.

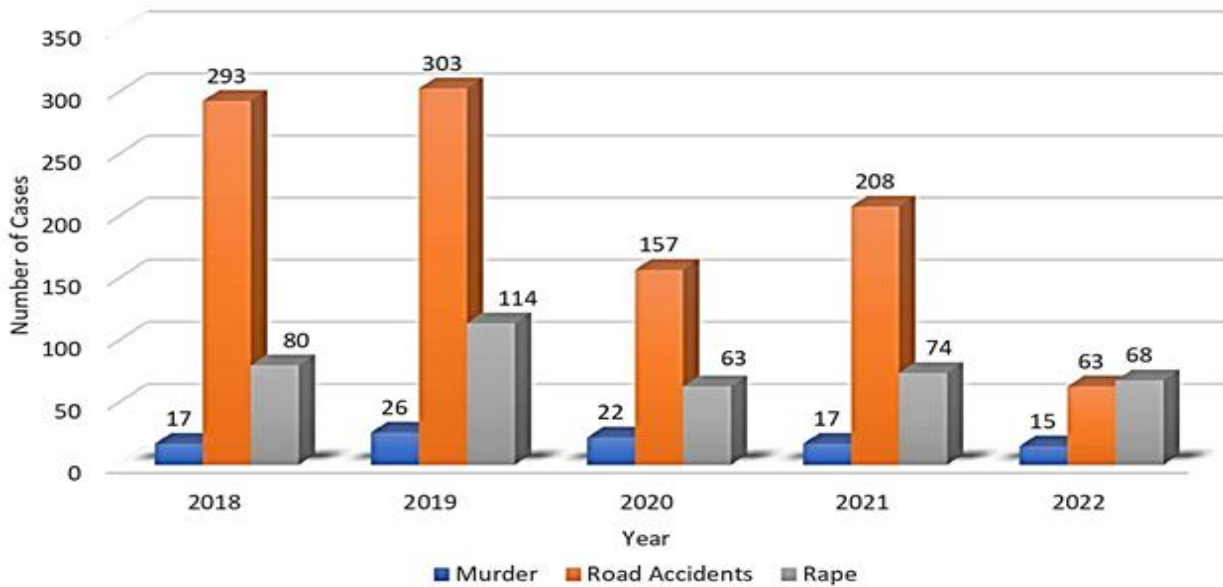

Graph-1: Data of crimes in last five years

And YES! You are thinking right that forensic science, harnessing various principles of physics, would be playing a vital role to solve these crimes.

Also in recent years, there has been an emphasis on community awareness to curb crime in Chandigarh. Public awareness campaigns and residents' active involvement have helped reduce criminal activities to some extent. Except for these three crimes, there are various other major crimes in Chandigarh as well.

You can get an idea of them from the Graph 2 given alongside.

While Chandigarh is generally considered safe, it is always prudent to stay informed, and take necessary precautions for your safety. Ultimately, it feels very good to see residents and law enforcement authorities working together to create a safer and more secure Chandigarh by fostering a sense of collective responsibility.

As per the official record of year 2022

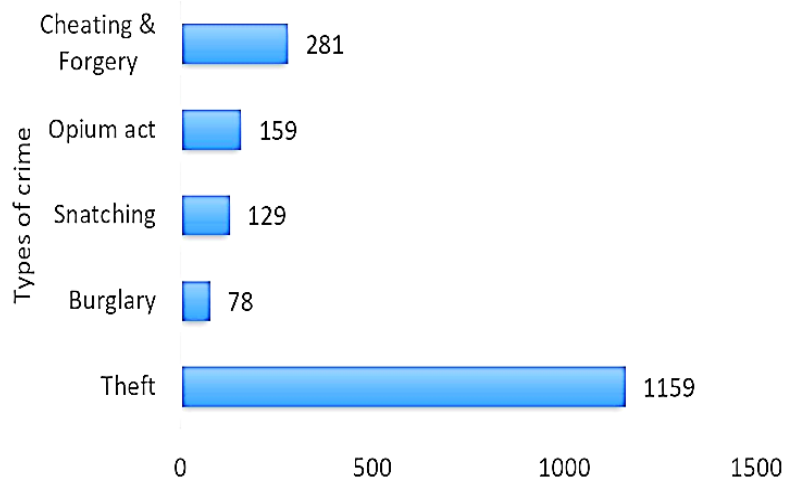

Graph 2: Data of various crimes in 2022

Conclusion

As you all would easily agree on the fact that the use of physics in forensic science is vast and diverse, contributing significantly to the pursuit of justice. Through crime scene reconstruction, physicists understand the sequence of events leading to a crime. Bloodstain pattern analysis interprets blood spatter patterns and provides crucial information about the nature of a crime. Ballistics and firearms analysis utilizes physics principles to examine the behavior of projectiles, match bullets to firearms, and reconstruct shooting incidents.

Physics-based techniques enable the recovery and analysis of electronic evidence, including the detection of tampering or encryption. Trace evidence analysis benefits from physics-based techniques such as spectroscopy, microscopy and the understanding of light interaction with materials to identify and link trace evidence to specific sources. Thus, the integration of physics principles into forensic science not only provides objective evidence but also enhances the accuracy, reliability and scientific rigor of investigations.

In the end, it would not be wrong to say that the use of physics in forensics has revolutionized the field, enhancing the accuracy, reliability and scientific rigor of investigations. The collaboration between forensic scientists and physicists harnesses the power of scientific knowledge, methodologies and technological advancements to uncover evidence, reconstruct events and provide objective insights into complex criminal cases. By embracing physics principles, forensic science continues to evolve, adapt and stay at the forefront of technological advancements, ensuring justice, truth and the well-being of society. The fusion of physics and forensics exemplifies the profound impact that scientific disciplines can have on the pursuit of truth and the maintenance of justice in society.

References

- Toni Feder; Physicists in forensics. Physics Today 1 March 2009; 62(3): 2022. <https://doi.org/10.1063/1.3099569>
- <https://forensicreader.com/forensic-physics-importance/>
- <http://www.fondelco.in/institute/forensic-physics.php>
- Mukesh Sharma. Fundamental Physics used in Forensics. Forensic Sci Add Res. 5(1). FSAR.000606.2019. DOI: 10.31031/FSAR.2019.05.000606
- Chandigarh's Crime Data: <https://chandigarhpolice.gov.in/crimecht.html>
- Wikipedia
- Image credits- Internet

PHYSICS IN FORENSIC SCIENCE

Aditya Kumar

Ramjas College, Department of Physics and Astrophysics, University of Delhi

➤ Introduction

Due to the large number of human activities that can be done by humans at crime scenes, the amount of physical information that can be used as physical evidence is virtually imperceptible to the human eye. This evidence can be microscopic such as DNA, skin, sperm, hair, etc. It can be microscopic as well as about the human body. Here's how we present forensic and physical evidence: Forensic (physicists), also known as scientists, can often use basic physics to explain their expertise. They gained great acclaim for scientific research through the use of direct physics, such as electron optics, laser light and modern physics, Optical microscopes, electron microscopes, mass spectrometers, spectrometers (optical physics) and other instruments. To put it bluntly, the role of physical examination in forensic medicine is not often used by investigators due to a lack of training. Forensic physics in crime lab always includes density (soil and glass), index measurement, birefringence measurement (fiber analysis, glass test), VIN structure, inspection equipment, etc. Special equipment from photoluminescence, EDX, XRF, SEM and XRD is used in physical evidence; the most important application is hidden fingerprint detection. Over the years, it has been at the forefront of analog and digital electronics (cybercrime) research.

➤ The Role of Physics in Forensic Science

Forensic science is a multidisciplinary field that involves the analysis and interpretation of evidence for forensic purposes. While biology, chemistry and other sciences play an important role in analysis, physics is also important. Physics provides important concepts and analytical techniques necessary to understand and reconstruct a crime scene, analyze evidence, and present findings in court. This article explores the importance of physics in forensic science and highlights its applications in various fields of forensic investigation.

- 1. Ballistics and Firearms Inspection:** Physics plays an important role in the inspection of firearms and the determination of bullet trajectories leads to weapon identification and bullet residue analysis. Using the principles of motion and fluid dynamics, forensic experts can calculate the trajectory of a bullet and determine its origin. Additionally, physics-based techniques such as microscopy, spectroscopy and high-speed photography help analyze and compare information about firearms, including bullet casings, bullet shot traces and reserve ammunition.
- 2. Bloodstain pattern analysis:** Bloodstain pattern analysis is based on physical principles. By taking into account factors such as tension, gravity and fluid quality, specialists can interpret the shape, size and distribution of blood at the scene. Physics equations regarding velocity, impact angle and kinetic energy help to reconstruct the events that cause blood. By analyzing blood samples separately, experts can determine the type of weapon used at the location of the victim and even the nature of the crime code.
- 3. Disaster Reconstruction:** Physics provides the framework for accident reconstruction, allowing investigators to understand the accident and determine the cause of the accident. By applying the

principles of kinematics, mechanics and conservation of energy, engineers can analyze the movement and interactions of vehicles, pedestrians or objects when an accident occurs. They can calculate speed, distance and angle of impact to help identify malfunctions, assess the severity of injuries and provide scientific evidence in court.

4. **Forensic Informatics:** Forensic informatics is based on the principles of physics, although it mostly involves computer and data analysis. Techniques such as electromagnetism signal processing and information theory are used to receive, analyze and interpret digital evidence. Physics-based technology helps to recover deleted files, identify fake files, analyses network traffic and decrypt encrypted files. In addition, the principles of physics form the basis for analyzing electronic devices such as computers and smartphones to obtain information for research purposes.

➤ **Elemental analysis of materials using X-ray fluorescence (XRF) technique**

XRF (X-ray Fluorescence) is an analytical technique widely used in scientific research. It is based on the principle that when an object is exposed to high-energy X-rays, it emits fluorescent X-rays with a characteristic energy or wavelength. The emission of X-rays can be measured to determine the content of the material under investigation. Some uses of XRF in forensic medicine include:

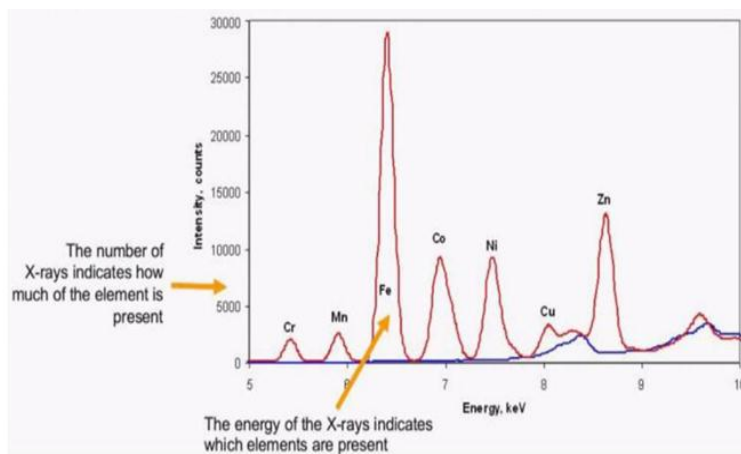

Figure-1

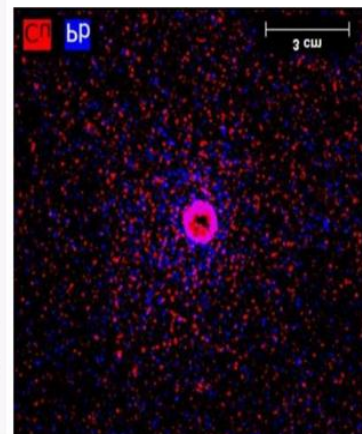

Figure 2 Gunshot Residue Analysis (GSR)

Source- <https://www.bruker.com/it/applications/detection-and-environmental/forensics/gunshot-residue.html>

- ❖ Firearm residue analysis: XRF is used to analyze firearm residue (GSR) left on gunmen's hands or clothing. By collecting samples from suspects and using XRF, forensic scientists can detect the presence of elements such as lead, barium and antimony, which are the main components of GSR.
- ❖ Paint and Coating Analysis: XRF is used for the analysis of paint, coatings and other evidence. By analyzing the details of these documents, forensic scientists can compare crime patterns, vehicles, or vehicles to determine whether they have different backgrounds.
- ❖ Glass fragment analysis: XRF can be used to identify broken glass found at crime scenes or on suspects. The structure of the glass, including particles and impurities can provide important information for comparing glass samples and attaching them to specific locations, such as a broken glass or a broken bottle.

- ❖ **Soil Analysis:** XRF is used in forensic soil analysis to determine the elemental composition of soil samples found on products, shoes or cars. By comparing the contents of different soil samples, forensic scientists can establish relationships between a particular location or crime scene and the collected samples.
- ❖ **Metal Analysis:** XRF is often used to identify evidence of metals such as weapons, tools or metal alloys. By analyzing key elements of these documents, forensic experts can provide information on their origin, identify potential matches for explosives and support the investigation of stolen or illegal metals.
- ❖ **Document Analysis:** XRF can be used for document analysis, especially ink analysis. By analyzing the composition of the ink, including the presence of certain elements such as iron, copper or titanium, forensic scientists can compare inks from different sources, verify changes or additions to the database and determine the age of the entry.
- ❖ **Jewelry and diamond analysis:** XRF is used to identify metals and gemstones. By measuring the basic composition of jewelry or diamonds, forensic experts can identify items, identify fakes or substitutes and provide information on their composition and history.

XRF is a non-destructive and versatile technique for rapid analysis of a wide variety of materials. Its ability to provide valuable information helps identify, compare and analyze different types of evidence, making it an important tool in forensics.

➤ **Combined XRF and SEM-EDS (Energy Scanning Electron Microscopy) analysis**

Take a sample of GSR from the suspect's hands or clothing using an adhesive or cotton swab designed for GSR collection. These samples are carefully collected from areas where weapons or bullets are suspected.

- ❖ **Sample Preparation for SEM-EDS:** Prepare collected GSR samples on adhesive strips or swabs for SEM-EDS analysis. Samples are mounted on conductive studs or strips to ensure good contact and stability during testing.
- ❖ **SEM imaging:** Prepared GSR samples were placed in a scanning electron microscope (SEM) for imaging. SEM scans the surface of the sample using an electron beam and creates high resolution images. SEM images provide detailed information on the morphology and distribution of GSR particles.
- ❖ **Analysis using EDS:** The SEM is equipped with a powerful Dispersive X-ray Spectroscopy (EDS) detector. The EDS detector measures the X-rays emitted by GSR particles when excited by an electric light. These X-rays contain important information.
- ❖ **XRF analysis:** In parallel with SEM-EDS analysis, XRF analysis can be performed on the same GSR sample. The sample was sent to the XRF analyzer. XRF equipment emits high-energy X-rays in a sample and fluorescent material is detected and measured.
- ❖ **Data Analysis:** Processing and analysis of SEM-EDS and XRF data. SEM-EDS data provides high- resolution images of GSR particles, while XRF data provides compositional information.

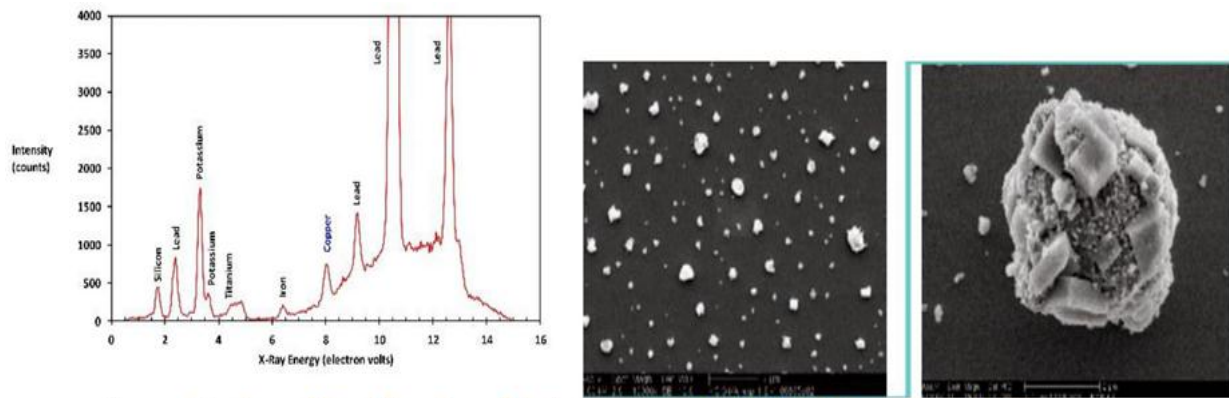

Source- http://www.911metallurgist.com/blog/wp-content/uploads/2015/09/how_xrf_works_001.png

Figure-3

Combine data from these two methods to obtain information about GSR particles, including their pictures.

Interpretation and Reporting: Interpretation of combined SEM-EDS and XRF data by forensic experts. They analyzed the morphology, distribution and content of the GSR particles to determine their significance in the research. Findings are documented in a report that provides scientific evidence for further analysis or legal action.

➤ Infrared and Raman Spectroscopy for Identification in Forensic science

Raman spectroscopy is a powerful analytical technique used in forensics to identify and analyze different types of evidence. It relies on inelastic light scattering, called Raman scattering, to provide information about the chemical composition and molecular structure of the sample. Below is a description of the applications and steps involved in the use of Raman spectroscopy in forensic medicine:

- ❖ Drug analysis: Raman spectroscopy is used for identification of illicit drugs. By analyzing the unique Raman spectra of different drugs, forensic scientists can determine the presence of certain drugs, including narcotics, stimulants and hallucinogens. This information is important for drug trafficking investigations and prosecutions.
- ❖ Analysis of explosives: Raman spectroscopy is used to identify and characterize explosives. The unique Raman spectra of various explosives allow scientists to detect and distinguish between explosives such as nitro-aromatics, nitrates and peroxides. This helps with forensic investigations related to bombing, arson and terrorism.
- ❖ Fiber and Textile Analysis: Raman spectroscopy is used to analyze the fibers and textiles found at the crime scene. By analyzing the Raman spectra of the fibers, forensic scientists can identify the type of fibers used in the fabric, determine the fiber composition and potentially link evidence to suspect or criminal activity.
- ❖ Dye and Pigment Analysis: Raman spectroscopy assists dye and pigment analysis. By examining the Raman spectra of these materials, forensic scientists can identify the type of pigments used, determine their content and provide valuable information for comparing color samples to products as suspicious or criminal evidence.
- ❖ Ink analysis: Raman spectroscopy is suitable for the analysis of the ink used in these documents. By analyzing the Raman spectra of inks, forensic scientists can determine the

chemical composition of inks; distinguish between different types of ink and gain insight into their relative ages and accuracy of ink entry.

- ❖ Forensic Geology and soil analysis: Raman spectroscopy is used to analyze geological samples and soils found at crime scenes. By analyzing the Raman spectrum of minerals and soil, forensic experts can identify and classify minerals, distinguish between soils and establish relationships between crime patterns and known geological sites.
- ❖ Evidence: Raman spectroscopy is used to analyze evidence such as firearm residue, fibres, hair, glass and paint chips. By focusing the Raman laser on specific objects or remains, forensic scientists can obtain chemical information that can help identify and compare the amount of evidence gathered from multiple sources.

➤ Drug analysis using Raman spectroscopy

Drug analysis using Raman spectroscopy involves several steps to identify and report illicit substances. Here are the step-by-step instructions for the process:

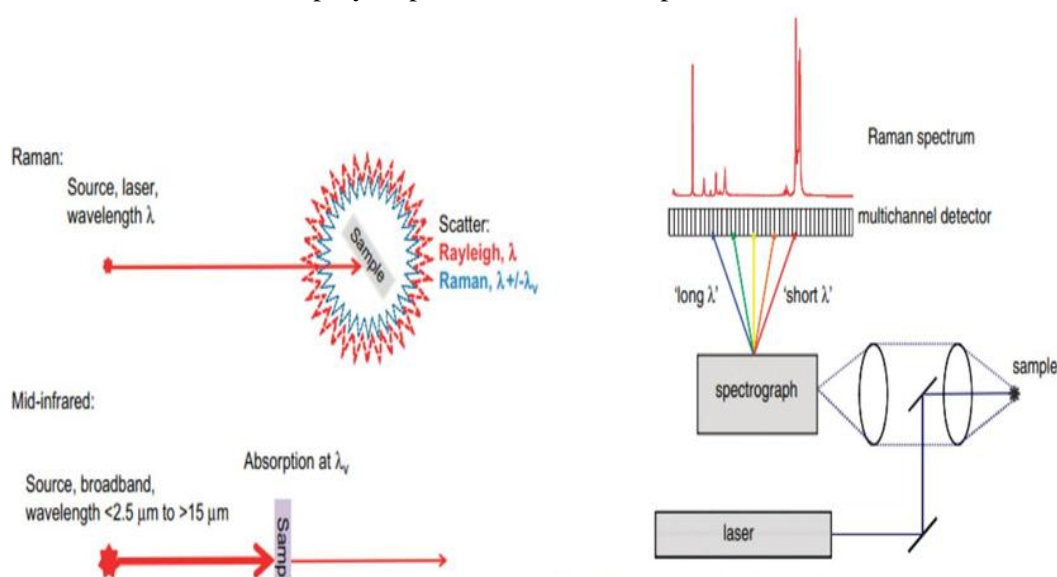

Figure-4: Schematic of a dispersive Raman spectroscopy set-up using a CCD detector

Figure-5: Simplified schematic comparison between Raman scatter and mid-IR absorption (transmission measurement) Source- Google images

Chemical samples are collected and prepared for analysis. This will involve taking small quantities such as powders or samples and placing them in a suitable container or bottle. The Raman spectroscopy instrument is set up and calibrated. This includes ensuring that the measurements are consistent, the laser position is stable and the gauges are well suited for certain inspections. This explosion occurs due to negative interactions between laser photons and molecular vibrations of chemical molecules. The detector generates a spectrum called the Raman spectrum, which represents the intensity of light scattering at different wavelengths. The spectrum has characteristic peaks that correspond to the vibrational patterns of chemical molecules. Raman Spectra were obtained to describe and characterize the API. Compare the spectrum with a reference spectrum or a database of known Raman spectra of illicit drugs. Forensic experts interpret results and create reports. They identify the drug based on the characteristic peaks seen in the Raman spectrum and provide information on its composition, purity and adulteration potential. The results were recorded as

scientific evidence for legal action. More importantly, Raman spectroscopy is a fast and non-destructive technique that enables in situ analysis of chemical samples

➤ **Spectroscopy technique to identify and characterize different types of explosives**

Collect suspected explosives and prepare for examination. Samples can be powders, solids or flakes. It is important to take care of the specimens to preserve their integrity and prevent disease. Raman spectroscopy device is set up and calibrated for the analysis of explosives. This includes ensuring alignment, optimizing laser power and wavelength, and installing appropriate detectors. When the laser interacts with the explosive, some of the photons are scattered and Raman scattering occurs. The scattered photons contain information about the molecular vibration and chemical composition of the particle. Scattering, including Raman scattering photons, is collected and sent to the detector in the Raman spectrometer.

The detector measures the intensity and wavelength of the scattered light. The detector generates a spectrum called the Raman spectrum, which represents the difference in light scattering at different wavelengths. The spectrum contains the peaks corresponding to the vibrational patterns of the molecules found in explosives. Raman spectra were analyzed to identify the fragments. Compare the spectrum with a reference spectrum or database containing Raman spectra of known compounds. Characteristic peaks and patterns in the spectrum help identify common explosives or classes of explosives. Forensic experts interpret Raman spectroscopy results and generate reports. They identified the explosives based on the characteristic peaks seen in the Raman spectrum providing information on their composition and related properties. Results are recorded as scientific evidence for further research or legal action.

Raman spectroscopy has many advantages for scientific analysis of explosives, including the ability to analyze samples quickly, non-destructively and the ability to identify samples from clear containers. It adds to other analytical methods such as gas chromatography-mass spectrometry (GC-MS) to provide identification and validation for scientific research of explosives.

➤ **Reconstructing Events Using Trajectory Calculation in Forensics**

In forensics, reconstructing events such as crimes or accidents will often be trajectory calculations. These calculations help determine the path of objects or participants in an event, give an idea of the sequence of events, the location of the date or the location of the bullets. Ballistic calculations are generally used in the following situations:

- 1. Testing Firearms and Explosives:** Ballistic calculations play an important role in the research of firearms. By examining bullet trajectories, forensic experts can determine the trajectory of the shot, including the angle of entry and exit and its origin. This information helps determine the location of the shooter or victim at the time of the incident. Factors included in ballistic calculations include projectile velocity, elevation or descent angle and the effect of gravity on projectile flight.
- 2. Bloodstain Pattern Analysis:** Trajectory calculations are used to analyze blood flow or spatter patterns at the crime scene. By examining the shape, size and distribution of blood, forensic experts can determine the angle and direction of blood flow. This information helps to understand the location and movements of people involved in a serious incident, such as shooting or stabbing.

3. **Crash construction:** Used to construct racetrack, car accidents or other situations involving moving objects. By analyzing tires, parking spaces, or the path of vehicles or pedestrians, experts can identify the conditions that caused the accident. These calculations include factors such as speed, distance, friction and the geometry of the surface to estimate the path taken by the object in question.
4. **Bullet analysis and impact:** ballistic analysis can be used to analyze the trajectory of bullets, such as bullets, thrown guns or moving objects. Forensic experts can determine the trajectory and possible impact of the projectile by taking into account its initial velocity, angle and gravity. This information can help determine the location of the bullet or the angle at which the weapon is used.

In effective trajectory calculations, forensic experts use physics principles such as kinematics, kinetics and the equation of motion of bullets.

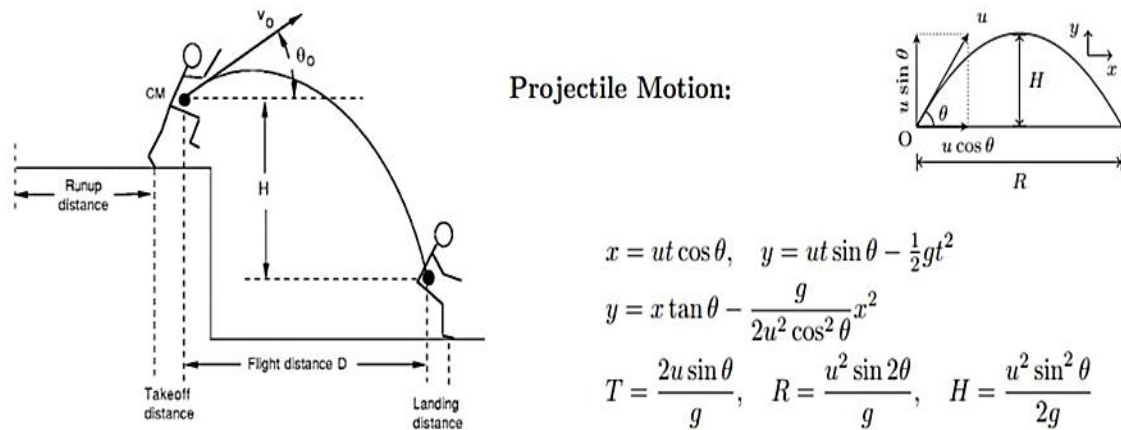

Figure-6

Source- <http://www.physics.usyd.edu.au/~cross/PUBLICATIONS/40.%20ForensicPhysics.pdf>

These calculations may include analyzing images, conducting field surveys, collecting physical evidence and using special software or mathematical models to simulate conditions. In addition, experts may consider other factors such as wind resistance, surface area and air resistance. It is worth noting that the orbit calculation will be limited and uncertain, as there are many factors involved in the orbit of objects in Earth scenes. Therefore, calculating the trajectory is often combined with other evidence and research methods to provide new reconstructions of relevant events.

➤ Bloodstain Pattern Analysis

Bloodstain Pattern Analysis (BPA) is a forensic technique used to analyze blood at a crime scene and obtain important information about the events leading up to them.

By analyzing the size, shape, distribution and other properties of the blood, forensic experts can reconstruct the blood process, such as the location of the blood, the type of force used, the direction and angle of impact and the location of the blood participants. Blood tests can provide important information about the nature of events, the nature of attacks or violence and people's locations and movements between locations.

The following are some important points in the analysis of blood samples:

1. **Types of blood samples:** Blood samples can be divided into different types according to their characteristics:

- **Related samples:** Samples Blood flowing from the surface. They may include splatters, spatters, and arterial jets.
 - **Pattern changes:** These occur when blood particles come into contact with an area, leaving visible marks or patterns. Examples include wiping, smearing and contact stains.
 - **Passive Patterns:** These patterns are caused by blood flowing or accumulating under the force of gravity. It includes streams, drops and lakes.
 - **Pattern preparation:** This pattern is formed when blood flows from a wound in the heart, such as dislodged spots or exhaled blood.
2. **Movement of a bullet:** Studying the movement of a bullet is important for understanding the flight of blood. When blood flows from a source such as a heartbeat, gunshot, or blow, it follows a path influenced by gravity, initial velocity and angle to which it is exposed. The principles of physics, including kinematics and equations of motion, help calculate the velocity, angle and distance of blood flow, determine their origin or influence.
 3. **Fluid Dynamics:** Blood is a complex fluid and its behavior can be analyzed using fluid dynamics concepts. Fluid mechanics laws, such as Bernoulli's principle, provide insight into the formation and structure of blood samples. Properties such as blood viscosity, surface tension and interaction of blood with the surface it hits affect the shape, magnitude and distribution of the effect. Understanding these principles can explain the dynamics and properties of blood samples.
 4. **Surface interaction:** When blood falls on the surface, it interacts with the surface, creating different types of blood samples. Physical concepts such as impact angle, contact angle and recovery coefficient help explain the splashing, breaking, or changing behavior of blood droplets during contact. By taking these physical effects into account, blood analysts can distinguish between different patterns and determine the angle and direction of the effect.
 5. **Pattern interpretation:** Bloodstain pattern analysts interpret observed patterns to reconstruct the events that caused them. They took into account factors such as the size and shape of the blood, the presence of satellite bounce, the angle of impact and the direction of blood flow. By focusing on these patterns, analysts can determine the relative position of individuals, the number of hits, the type of weapon used, and other important details about the incident.
 6. **Mathematical and scientific analysis:** Analysis of blood samples often involves mathematical calculations and scientific concepts to aid interpretation. These may include determining the point of convergence or origin, measuring the angle of impact, estimating the blood flow velocity and using mathematical models or software simulation models.

Bloodstain pattern analysis is an important tool in forensic investigations that helps improve crime, victim and accident cases. It helps provide a scientific understanding of the phenomenon and aids in general research.

Collision engineering professionals can measure the amount of force, velocity and forces involved in a collision using the principles of physics. This information allows them to determine factors such as vehicle speed, angle of impact, sequence of events and causes of the accident. Integration of physics with other forensic disciplines, engineering principles and empirical data increases the accuracy and reliability of disaster reconstruction.

➤ Hemoglobin Aging Process in Blood : Raman Spectroscopy

Hemoglobin is the oxygen-carrying protein in red blood cells. Over time, hemoglobin has undergone a process called aging associated with structural and chemical changes. Blood Raman spectroscopy can provide insight into the aging process of hemoglobin by examining the specific features associated with these changes. The resulting Raman scattering light contains information about the molecular composition and structure of the sample.

Spectral analysis: Raman spectra of the obtained blood samples were analyzed and specific features associated with aging hemoglobin were determined. Raman spectra usually have different peaks than the molecular vibrations in the sample. In the case of aging hemoglobin, changes in Raman spectroscopy may indicate changes in hemoglobin structure or chemical modifications.

Spectral changes associated with aging: Aging of hemoglobin is associated with several changes in Raman spectroscopy:

- **Changes in heme structure:** heme is iron containing hemoglobin. During aging, the heme structure can change, resulting in changes in Raman spectral properties associated with heme vibrations. These changes can give an idea about the oxidation or degradation state of the heme.
- **Protein structure change:** The aging of hemoglobin will affect changes in protein structure, which in turn affects the Raman spectral properties associated with protein vibrations. These changes may result from processes such as denaturation, crosslinking or glycation of hemoglobin.
- **Chemical modification:** Aged hemoglobin can undergo chemical modification, such as glycation or oxidation, which introduces new spectral properties or changes the intensity of existing peaks in the Raman spectrum. These changes may indicate the length of hemoglobin aging and affect overall health.

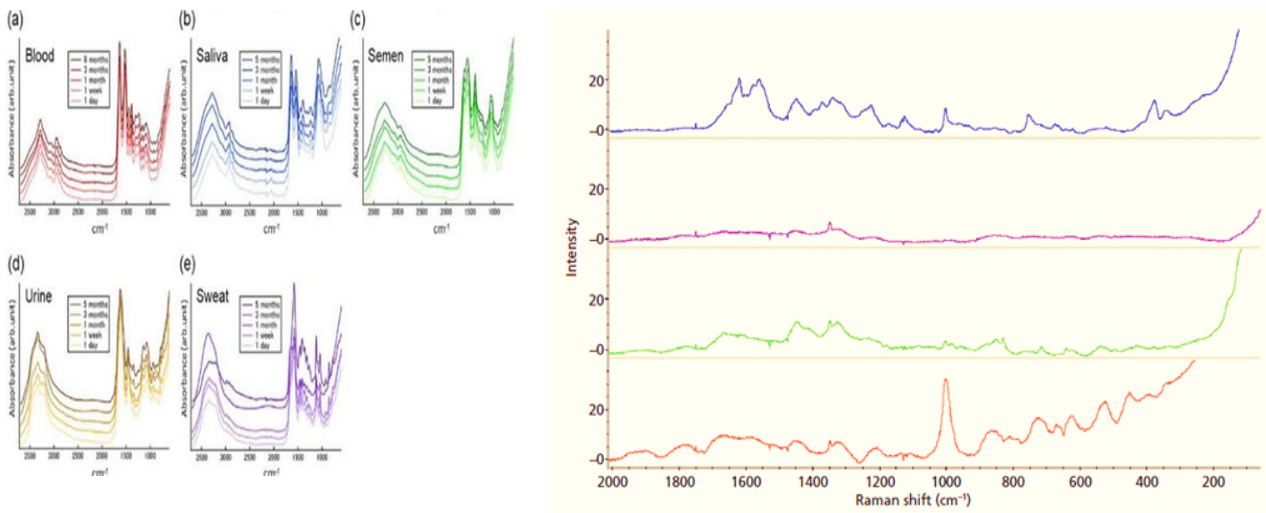

Figure-7

Source - <https://www.spectroscopyonline.com/view/use-raman-spectroscopy-identification-forensically-relevant-body-fluid-stains>

Data Analysis and Interpretation: Multivariate data analysis methods such as Raman Spectrum Principal Component Analysis (PCA) or partial least squares regression (PLSR) obtained by statistical and spectroscopic analysis methods to extract useful information about ancient hemoglobin, It can be used to analyze spectral models or the relationship between spectral changes and processes.

Comparison and validity: Raman spectroscopic analysis results can be compared with reference spectrum data or additional archived data to effectively see changes in aging hemoglobin. Additionally, correlations with other clinical or biochemical markers can be made to assess the significance of spectral changes. It is important to note that the specific content of Hemoglobin and its characteristics according to Raman spectroscopy may change depending on ongoing study or research. Different research groups may focus on specific regions or molecular markers associated with hemoglobin aging.

Therefore, the exact process and business analysis process will be slightly different.

➤ **Infrared Spectroscopic Analysis of Hemoglobin Aging in Blood**

Hemoglobin Aging refers to the structural and chemical changes that occur in the hemoglobin molecule over time. Infrared (IR) spectroscopy can provide valuable information about the aging process in blood samples. Here is an example of how IR spectroscopy is used to study the aging of hemoglobin. Infrared light is absorbed by the structure, causing the molecules to vibrate and rotate, resulting in a specific absorption spectrum that can be measured and analyzed.

Infrared Spectrum Collection: The infrared spectrometer measures the absorption of infrared light at several frequencies to form the infrared absorption spectrum of the blood sample. The spectrum

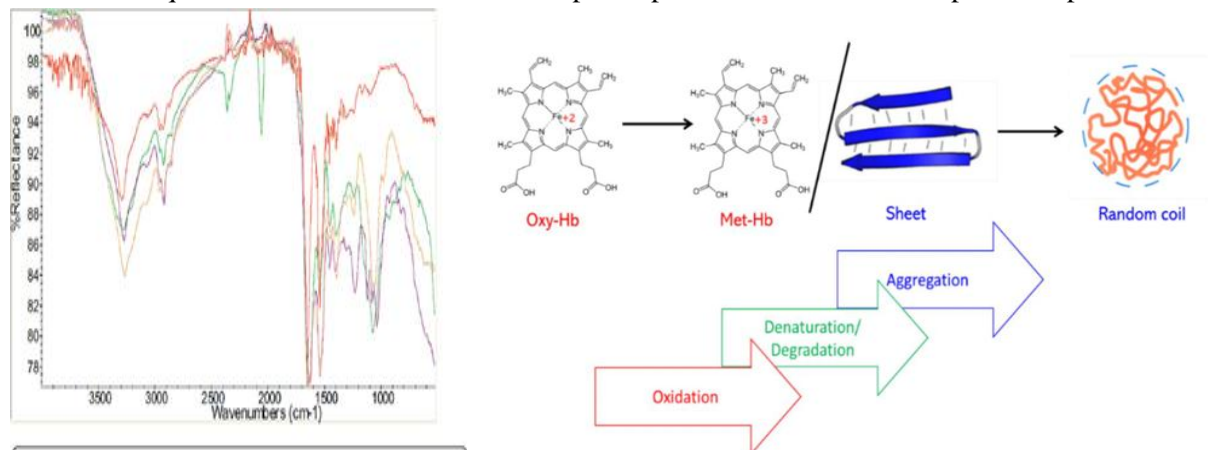

Figure-8: ATR FTIR spectra of blood (red), semen (orange), saliva (green) and vaginal secretions (Purple). Adapted with permission from [25]

Source – Process of hemoglobin aging in blood. Credit: Hemoglobin structure from Yikrazuujul sheet structure from Thomas Shaefer, and random coil structure from Daniele

represents the energy absorbed by the sample at various vibrational frequencies and provides information about the chemical composition and structure of the sample, including hemoglobin.

Spectral Analysis: The resulting infrared spectra were analyzed to identify specific features associated with aging hemoglobin. Hemoglobin has the ability to absorb dust in the infrared region, which corresponds to certain molecular vibrations. Changes in the intensity, location, or shape of these bands may indicate age-related changes or chemical changes in hemoglobin structure.

Spectral Changes Due to Aging: Aging of hemoglobin can manifest in various ways in IR spectroscopy:

- Protein secondary structure: Aging affects the secondary structure of hemoglobin, causing a shift between the amide I and amide II absorption bands.

These lines are associated with the bone marrow and can provide insight into changes in hemoglobin.

- **Chemical changes:** Aging of hemoglobin can include chemical changes such as oxidation or glycation. These modifications can introduce new absorption bands or change the intensity of existing bands in the infrared spectrum. For example, oxidation can cause a change in the intensity of heme-associated bands.
- **Hydrogen Bonding:** Aging changes of hydrogen bond interactions in the hemoglobin molecule can be detected, particularly by changes in the intensity of infrared lines associated with hydrogen bonding.

Confirmation and correlation: Results from infrared spectroscopic analysis can be used by comparing them with other models generated by aging analysis of hemoglobin, such as biochemical analysis or diagnostic markers. Correlation studies can also be performed to assess the relationship between spectral changes and clinical or functional hemoglobin aging.

Infrared spectroscopy provides a powerful tool to study the aging of hemoglobin in blood samples. It is possible to identify the structural changes, chemical modifications and altered hydrogen bonds that occur during hemoglobin aging. These data provide a better understanding of age-related changes in blood composition and function.

Conclusion: Physics plays an important role in all aspects of forensic science by providing a scientific basis for understanding crimes, analyzing evidence and reconstructing events. Using the concepts of ballistics, fluid dynamics, mechanics and optics, forensic experts can interpret complex evidence and present findings effectively in legal proceedings. Integration of physics with other scientific disciplines increases the accuracy and reliability of forensic science, contributes to justice and ensures justice.

PHYSICS IN FORENSIC SCIENCE

Kavita Asawara

Department of Physics, IPS Academy, Indore

Forensic Physics deals with the use of scientific knowledge of physics in the investigation and adjudication of judicial laws (criminal and civil).

Forensic science has been around for a long time and many people and cultures have contributed to its development. In ancient China, fingerprints were used to identify people. In the 16th century, an Italian doctor named Fortunato Fidelis used autopsies to figure out how people died in criminal cases. In the 19th century, a Scottish doctor named Henry Faulds discovered that fingerprints could be used to identify people and this idea was expanded on by Sir Francis Galton. In the 20th century, forensic science became even more advanced with new techniques and technologies. Forensic science is a field that uses science to investigate crimes and legal cases. Scientists use many different techniques to analyze evidence, such as DNA, fingerprints, hair, fibers, and bloodstains, to help solve crimes. They also look at documents like handwriting and signatures and use ballistics to match bullets to guns.

They also use physics to analyze blood spatter patterns, determine the height of a fall and identify the source of a fire. In addition, forensic physicists use x-rays and other imaging techniques to examine bones and other evidence. Overall, physics is an essential tool in forensic science, helping to solve crimes and bring justice to victims.

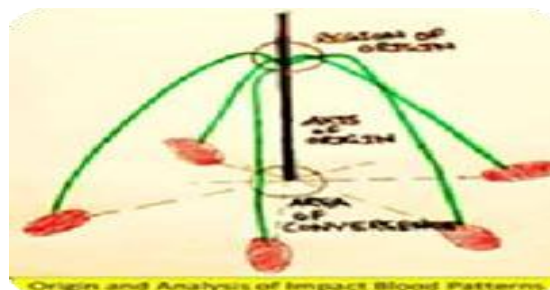

Role of Physics in Forensic Science

1. Ballistic is itself a physics in which it is free moving body with momentum which is subjected to forces such as forces exerted by pressurized gases from a gun barrel during flight. In this case experts examine the given points i.e., from where bullets were fired, its path, which gun is used for crime, rate of twist (how much bullet spins and how much force exerted by bullet and its velocities).
2. The blood spatters involve physics: from the drop angle to the position of victim. A careful examination can make a good spatter a good piece of evidence. In this procedure forensic experts determine the position/movement of the victim and objects at the scene this is help in defining: the probable height of victim, their scene position, whether the body is moved and whether the object is moved or missing from the crime scene. Forensic physics also helps in determining types of weapons, number of blows, shots, stabs etc. And high velocity or low velocity spatters. There is impact of different kinds of energies (low, high, and medium) which causes the size of droplets increases or decreases. If energy impact is high then droplet's size will decrease and vice versa.

Blood Spattered in Different Velocities

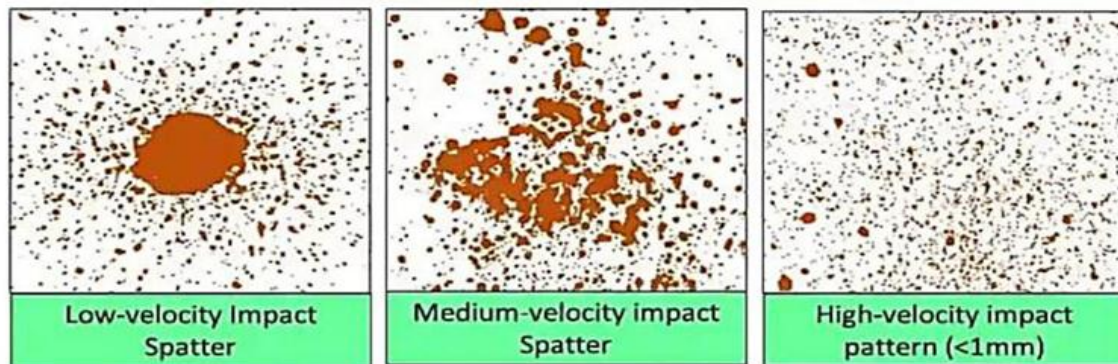

3. With a Projectile Hit the Target and Recoil: When there is an action of propulsion of bullet there is an equal and opposite reaction that set firer back. That we called recoil velocity and the force/velocity of impact back to firer is called terminal velocity. Experts can determine the recoil velocity using the formula

$$V = mv/M,$$

Where, m and M are the masses of the bullet and gun respectively.
 v and V are the velocities of the bullet and gun respectively.

4. **Searching for explosion parameter:** By using forensic physics, the radius of the blast area and point can be determined. Calculation of explosion scene parameter is $(x+y)$ where, x = farthest distance from the seat at which fragments are found and y = half the distance of x .

5. Physics in analysis of glass evidence:

Density Measurement of Glass:

Step 1: Sample Collection

Similarly, to soil, forensic investigators collect glass samples found at the crime scene or from objects related to the case. The samples are carefully handled and packaged to preserve any potential evidence.

Step 2: Measuring Mass and Volume

The mass of the glass sample is measured using a laboratory balance. The volume of the glass sample can be determined using the Archimedes' principle, where the sample is submerged in a liquid with a known density, and the displaced volume is measured.

Step 3: Calculating Density

The density of the glass sample is calculated by dividing its mass by its volume. The result is typically expressed in grams per cubic centimeter (g/cm^3) or kilograms per cubic meter (kg/m^3).

6. **Soil analysis:** It is related to soil, rock, or mineral samples taken from any item such as shoes, clothes, or vehicles present in any crime scene with a specific location. For this, some methods like – X-ray Diffraction, DRIFT method and Mass and Volume, Magnetic Susceptibility methods are used.

7. Facial Reconstruction: Software systems for facial reconstruction utilize databases to calculate the thickness of facial tissues, based on the person's individual traits. The software then places facial features such as eyes, nose, mouth and ears based on anthropological and statistical information. The software begins by morphing a generic face to create a preliminary facial approximation. Forensic artists then refine the approximation to create a more precise representation, based on their knowledge of facial anatomy and structure. The last step produces a 3D facial reconstruction that approximates the individual's appearance when they were alive, which can be used to help with identification

The Refractive Index (n) is an important optical property that describes how light travels through a material. It is calculated by dividing the speed of light in a vacuum (c) by the speed of light in the material (v). Different materials have different refractive indices and this property can be used for various purposes, such as fiber analysis.

In fiber analysis, the concept of "brief fringes" is often used to refer to the interference patterns that are observed when light passes through an optical fiber. This is due to the principle of total internal reflection, which occurs when light traveling through a denser medium (e.g., glass core of the fiber) encounters a less dense medium (e.g., fiber cladding) at an angle greater than the critical angle. The analysis of these fringes can provide valuable information about the fiber's characteristics, such as its refractive index profile, numerical aperture and any irregularities or defects along the fiber length. This information is essential for designing and optimizing the performance of optical fibers used in various applications, including telecommunications, fiber optic sensors, and medical devices.

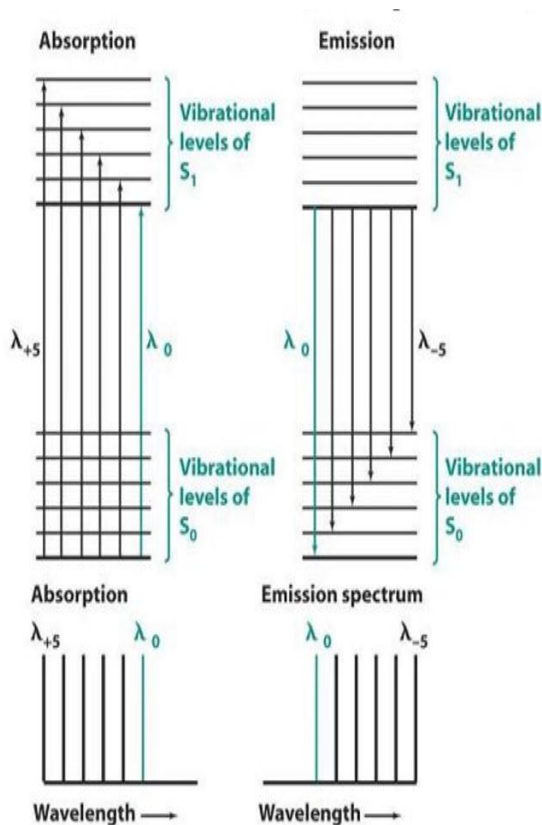

In conclusion, the refractive index is a fundamental optical property that is essential for understanding how light propagates through a material. It is used to analyze the optical properties of optical fibers, and the analysis of "brief fringes" can provide valuable information about the fiber's characteristic.

Instruments/ Techniques used in detection process:

Photoluminescence Phenomenon in which (when light made to fall on a sample surface stimulates the emission of a photon) a material emits light when exposed to light. This phenomenon is utilized in forensic science to detect and analyze minuscule amounts of substances that are not visible to the unaided eye.

Forensic science often employs photoluminescence to examine fingerprints and fibers. When a fingerprint is exposed to a certain type of light, it can cause the fingerprint to give off light making it easier

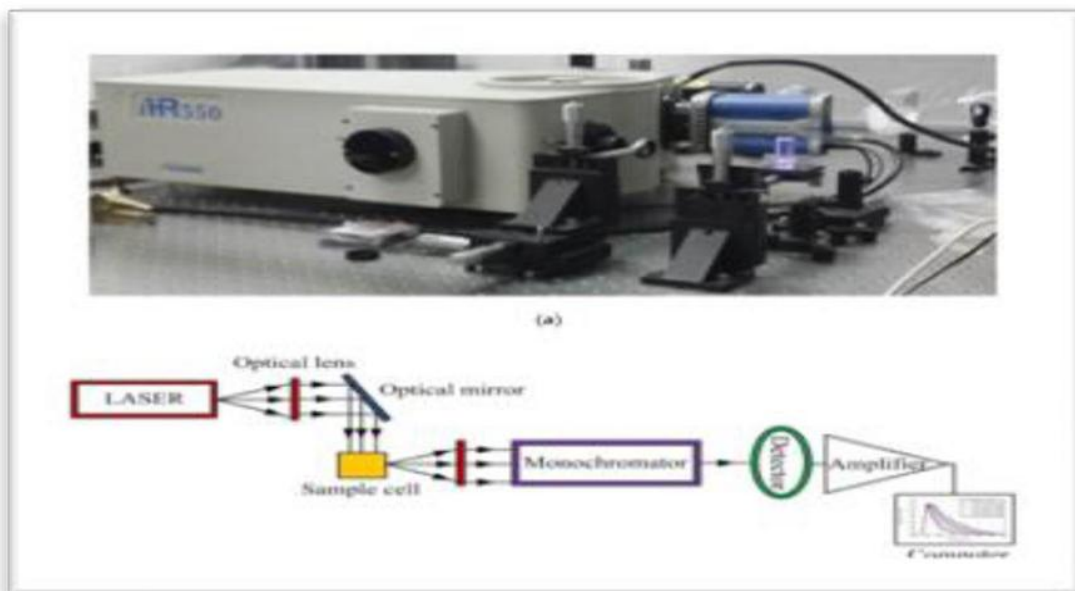

to observe and analyze. Similarly, when fibers are exposed to light, they can emit light of a different hue, which can help determine the type of fiber.

Photoluminescence can also be used to analyze drugs and other substances. When certain substances are exposed to light, they can emit light of a particular color, which can help identify the substance.

This property has numerous applications in various fields, including forensic science. Here are some ways photoluminescence can be used in forensic investigations:

- Counterfeit detection
- Forensic marking and tracking
- Fingerprint detection
- Bloodstain detection
- Document examination
- Drug and toxin detection
- Environmental monitoring

In conclusion, photoluminescence is a powerful tool in forensic science that can help identify and analyze minute amounts of materials that may otherwise go unnoticed.

Mass spectrometry (MS) is known as “the near-universal test for identifying unknown substances.” For decades, forensic teams have used MS to identify drugs in and outside the body. Scientists today still consider this method the gold standard in instrumental analysis tools.

LA-ICP-MS (Laser Ablation-Inductively Coupled Plasma Mass Spectrometry) is a high-tech device used to analyze trace matter samples in forensic science and other areas of science. This device uses a pulsed laser to vaporize a small amount of a solid sample, which is then transported into a high temperature plasma where it is ionized before being extracted into a mass spectrometer for analysis. LA-ICPMS offers improved sample size, sensitivity and speed when compared to traditional methods, and can detect microscopic samples such as clothing fibers and glass fragments at a level of parts per billion (ppb). This expensive technology is an important tool in combating domestic and international crimes and requires an increasingly innovative and systematic use of forensic science.

Before the availability of LA-ICPMS as a method for analyzing forensic samples and characterizing physical evidence, forensic scientists used such traditional techniques as Fourier transform infrared (FTIR) analysis, microscopy, refractive index and X-ray fluorescence (XRF). However, these older techniques were not always able to analyze small samples or discriminate between chemically, physically and visually similar materials. Some older techniques also required lengthy preparation times for the samples and used hazardous substances within the analysis, which both increased the potential for sample contamination and destroyed large amounts of samples.

Principle of inductively coupled plasma ICP

The ICP-OES principle relies on those excited atoms releasing light at specific wavelengths as they transit to a lower energy level. As an electron returns from a higher energy level to a lower energy level, usually the ground state, it emits light of a very specific wavelength. Inductively Coupled Plasma Optical Emission spectroscopy (ICP-OES) is an analytical technique used to determine how much of certain

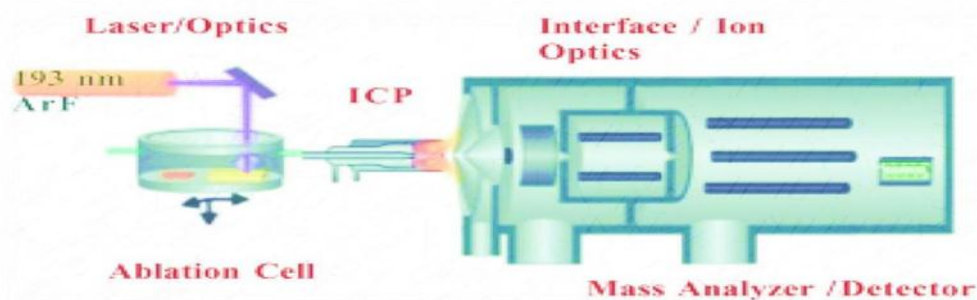

Instrumental arrangements of LA-ICP-MS

elements are in a sample. The ICP-OES principle uses the fact that atoms and ions can absorb energy to move electrons from the ground state to an excited state.

Here, Ablation allows control over material properties using process parameters including laser tuning and multi-target precursors. Furthermore, for some applications, pulsed laser ablation can also be used to vaporize materials that cannot be readily evaporated.

The electron microscope: The electron microscope is an invaluable instrument employed in forensic science for the purpose of analyzing and recognizing trace evidence. This microscope utilizes a beam of electrons to generate high-resolution images of small objects, allowing forensic scientists to inspect evidence at a microscopic level.

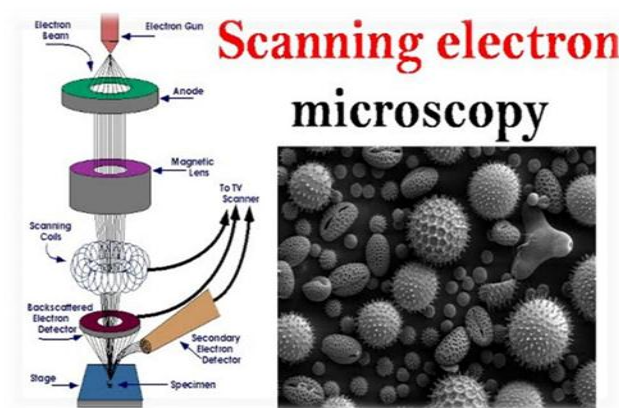

One of the primary applications of the electron microscope in forensic science is the examination of gunshot residue. When a firearm is discharged, it leaves behind minuscule particles that can be studied to determine the kind of gun that was used. The electron microscope can be used to analyze these particles and provide useful information to investigators.

The electron microscope is also used to analyze fibers, hair and other materials

involved in accidents and match trace evidence to specific sources. Spectroscopy is a method that uses ultraviolet light to identify and analyze chemical compounds. On the other hand, MRI (Magnetic Resonance Imaging) is a non-invasive medical imaging technique that uses magnetic fields and radio waves to generate detailed images of the body's internal structures. In legal science, MRI is used to draw non-harmful evidence from miscellaneous matters and entities. Overall, these methods demonstrate how physics can be used in a variety of ways to help solve cases and provide evidence in legal science. By combining physics with other disciplines like plant structure and mathematical reasoning, legal science can play an important role in the pursuit of fairness and justice in criminal cases.

PHYSICS IN FORENSIC SCIENCE

Rahul Vishwakarma

Department of Physics, Marwari College, Ranchi

The profound significance of Forensic Science in criminal investigations can be concisely captured by the renowned Fiction Writer, Chuck Palahniuk.

Everything is a self-portrait, a diary, your whole drug histories in a strand of your hair. Your fingernails the forensic details the lining of your stomach is a document. The calluses on your hand tell all your secrets. Your teeth give you away. Your accent, the wrinkles around your mouth and eyes everything you do shows your hand."

Forensic science is a multidisciplinary field that involves the application of scientific principles and techniques to investigate and solve crimes. It plays a crucial role in the criminal justice system by providing scientific evidence that can be used in court to establish facts and support or refute theories.

The primary goal of forensic science is to collect, analyze and interpret physical evidence from crime scenes. This evidence can include anything from fingerprints, DNA, firearms, tool marks, fibers and other trace materials. By examining and evaluating these pieces of evidence, forensic scientists can reconstruct events, identify perpetrators and contribute to the overall understanding of a crime.

Forensic science draws upon various scientific disciplines, such as biology, chemistry, **physics** and mathematics. It combines knowledge from these fields to analyze evidence using specialized techniques and instruments. Forensic scientists follow a systematic approach to ensure the accuracy and reliability of their findings, adhering to strict protocols and maintaining a chain of custody to preserve the integrity of the evidence.

Different branches within forensic science focus on specific areas of expertise. Some of the main branches include:

1. **Trace Evidence Analysis:** Based on Locard's Principle, which states that "**everything leaves a contact**", the examination of trace evidence plays a vital role in establishing connections to the culprit. Trace evidence encompasses various materials transferred during the commission of a crime, such as human or animal hair, rope, soil, fabric fibers, feathers and construction materials. The process of Trace Evidence Analysis involves the retrieval of such evidence and their forensic scrutiny to gather valuable information that can be utilized in court proceedings related to a case or to address any other legal inquiries.
2. **Forensic Toxicology:** This branch deals with the identification and analysis of drugs, poisons, and other substances in the human body. It plays a critical role in determining the cause and manner of death in cases involving drug overdoses, poisoning, or intoxication.
3. **Forensic Ballistics:** Ballistics experts analyze firearms, bullets and cartridge cases to determine their source and link them to specific firearms. They can provide valuable information about the type of weapon used the trajectory of bullets and the sequence of shots fired.

4. **Forensic Pathology:** The branch of pathology that deals with the examination of a corpse to determine the cause of death is called Forensic Pathology. It involves the deduction of facts admissible in the court of law by collecting and analyzing medical samples. For example, a forensic pathologist can examine a wound to identify the weapon used to cause that. Therefore, forensic pathology helps draw crucial inferences on whether the death is natural, criminal or accidental.
5. **Forensic Entomology:** The field of Forensic Entomology revolves around the utilization and examination of insect biology and other arthropods, including arachnids, centipedes, millipedes, and crustaceans, to resolve criminal investigations. This specialized discipline primarily focuses on cases involving human remains in various stages of decomposition. By studying the presence and behavior of these organisms, forensic entomology plays a crucial role in determining the time and location of incidents, estimating the postmortem interval and ultimately establishing the precise timing of inflicted wounds.
6. **Forensic DNA Analysis:** DNA profiling is commonly used to establish identity, link suspects to crime scenes and exonerate innocent individuals. It involves extracting DNA from biological samples and comparing it to known samples to determine matches or exclusions.

7. **Forensic Botany:** Forensic Botany, as its name suggests, involves the scrutiny and analysis of plant- derived evidence such as leaves, flowers, wood, fruits, seeds and pollen, serving as a valuable resource in both criminal and non-criminal investigations and addressing other legal queries. While still relatively underutilized in forensic investigations, the application of botany has proven instrumental in certain complex cases, aiding investigators in determining the manner and time of death. Recovered botanical trace evidence from a crime scene frequently plays a pivotal role in establishing vital connections to the suspect(s).



Figure 1: Human Factors in Forensic Science

8. **Forensic Engineering:** Surprisingly, there exists a distinct field within forensics dedicated to investigating incidents where products, materials, mechanical components, or structures fail to perform as intended, leading to personal injury or property damage. This field is known as Forensic Engineering. It encompasses the utilization of engineering principles to examine and analyze the causes behind these mechanical and structural failures. Forensic Engineering serves as a specialized discipline aimed at unraveling the mysteries behind such incidents and providing valuable insights into the factors contributing to their occurrence.

While forensic physics is not commonly recognized as a separate branch of forensic science, the principles and techniques of physics are applied in various aspects of forensic investigation. Physics plays a crucial role in analyzing and interpreting physical evidence, particularly in areas such as ballistics, accident reconstruction and the examination of physical properties of materials.

In the context of forensic science, physics can be applied in several ways:

- **Ballistics:** Forensic ballistics involves the analysis of firearms, projectiles and related evidence. Physics principles are used to study the trajectory of bullets calculate the speed and energy of projectiles and determine the source of firearm discharge.
- **Accident Reconstruction:** Physics is utilized to reconstruct accidents by analyzing factors such as vehicle speeds, impact forces and motion patterns. By applying principles of mechanics, kinematics and energy, forensic experts can recreate and understand how an accident occurred.
- **Forensic Engineering:** Physics is employed in the examination of structures, materials and mechanical systems to determine causes of failure or accidents. By studying factors such as stresses, strains and material properties, forensic engineers can identify the root causes of structural collapses, product failures, or accidents.
- **Fire Investigation:** Physics principles are used to understand the behavior and characteristics of fires. Forensic fire investigators employ concepts such as heat transfer, combustion and fire dynamics to determine the origin and cause of a fire.
- **Digital Forensics:** While not directly related to physics, digital forensics relies on the application of scientific principles, including some from computer science and information technology. It involves the analysis of digital devices, data recovery and the identification of digital evidence in computer systems, networks, or digital storage media.

These examples illustrate how physics concepts and methodologies are integrated into various areas of forensic science. While forensic physics may not be considered a distinct branch, physics serves as a fundamental and valuable tool in understanding the physical aspects of a crime scene, providing scientific evidence and assisting in the reconstruction of events.

The crime detection process relies on a variety of advanced instruments and cutting-edge techniques to uncover crucial details and evidence. These sophisticated tools play a pivotal role in aiding forensic experts and investigators in solving complex cases. Some of the key **instruments and techniques** utilized in crime detection include:

(a) Microscope/electron microscope

- Optical microscopes are commonly used in crime investigation for examining a wide range of evidence. Optical microscopes help forensic experts analyze hairs and fibers found at crime scenes or on suspects. They can determine characteristics like color, texture and other microscopic features that can link or differentiate evidence. When a crime involves the use of tools or weapons, forensic experts can use optical microscopes to compare and match tool marks left on various surfaces, such as metal, wood, or glass. This can help identify the potential weapon used in the crime. Microscopic analysis of bullet casings, striations and other firearm-related evidence can be performed using optical microscopes to link bullets to specific firearms. For cases involving questioned documents, such as forged signatures or altered documents, optical microscopes can be used to scrutinize ink, paper and other features to determine authenticity. Various trace evidence, such as paint chips, glass fragments or soil particles, can be

examined under an optical microscope to establish links between suspects, crime scenes and objects.

- Electron microscopes, especially the Transmission Electron Microscope (TEM), offer even higher magnification and resolution, allowing for in-depth analysis of extremely small and detailed samples. Electron microscopes can be employed to study gunshot residue particles left on suspects' hands or clothing to determine if

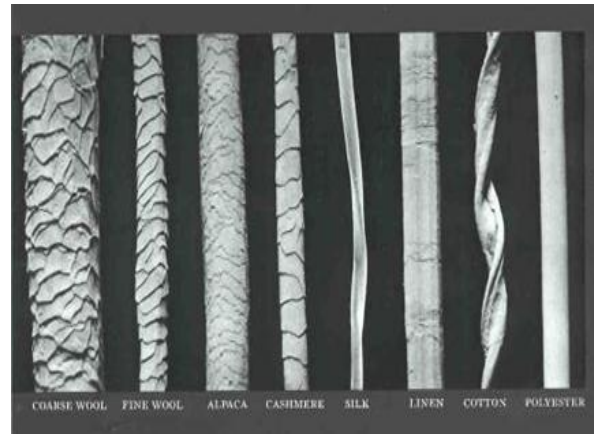

Figure 2: Comparison of Fibers by Microscopy

they have recently fired a weapon. In cases involving illegal drugs or toxic substances, electron microscopes can identify and characterize nanoparticles and other microscopic materials that may be present. If an unknown substance is found at a crime scene, electron microscopy can help identify its chemical composition and potential origin. Electron microscopy can be used in forensic pathology to study tissues and cells in greater detail, aiding in the determination of the cause of death or the presence of specific diseases or toxins.

(b) Mass spectrometry

Mass spectrometry is another powerful tool used in crime investigation and forensic science. Mass spectrometers are analytical instruments that measure the mass-to-charge ratio of ions, allowing for the identification and quantification of molecules in a sample. They have various applications in forensic analysis, helping investigators to gather valuable information from different types of evidence. Mass spectrometry is commonly employed to identify and quantify drugs and controlled substances in forensic toxicology. It can determine the presence of drugs in bodily fluids, tissues, or

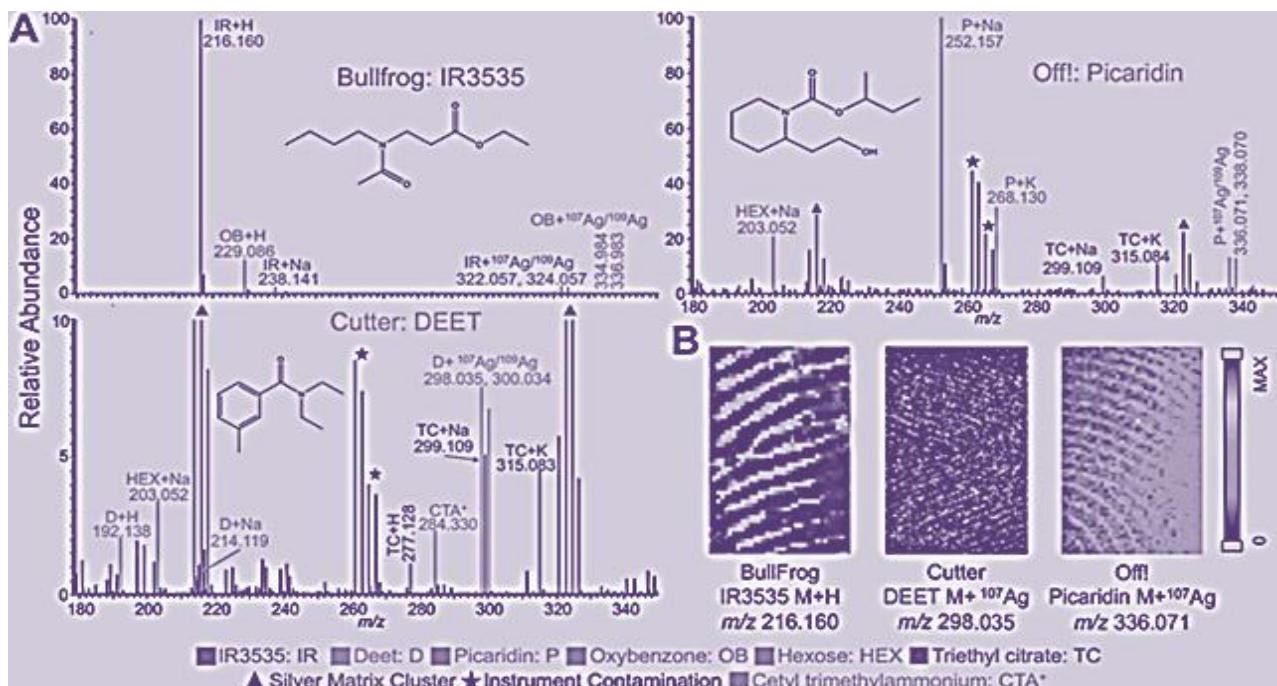

Figure 3: (A) Representative positive mode mass spectra of fingerprints containing three bug spray brands (BullFrog, Cutter, and OFF!) by MALDI-MSI with silver sputter. (B) Chemical images of the three active ingredients.

seized substances, aiding in cases involving drug- related offenses or toxicology investigations. Mass spectrometry is used to detect and analyze trace amounts of explosive residues in samples collected from crime scenes or suspects. This information can help link suspects to explosive-related crimes, such as bombings or terrorist activities. This can assist in identifying and comparing paints, inks and dyes found at crime scenes or on evidence like clothing, vehicles, or documents. This information can link suspects or objects to specific locations or events. Mass spectrometry is used to study biological samples, such as blood, urine and other body fluids. In forensic DNA analysis, it can be used to confirm the presence of specific genetic markers, assisting in the identification of suspects or victims, analyze gunshot residue to provide information about the ammunition used, such as the type of bullets or gunpowder. This data can help link firearms to specific crime scenes or weapons.

(c) Photoluminescence phenomenon

Photoluminescence is a phenomenon in which a substance absorbs photons (light energy) and then emits photons of a lower energy level, resulting in the emission of light. This phenomenon is widely used in various scientific fields, including crime investigation and forensic analysis. Photoluminescence plays a significant role in analyzing and identifying different types of evidence. In the field of document examination, photoluminescence is used to identify forged or altered documents. Different inks and materials can exhibit distinct photoluminescence properties. By exposing documents to specific wavelengths of light, forensic experts can detect discrepancies in the luminescence of various inks or coatings, revealing potential alterations or additions. Photoluminescence is used to examine banknotes and currency to verify their authenticity. Many modern currencies have security features that emit specific fluorescent patterns or colors when exposed to ultraviolet (UV) light. Law enforcement agencies and financial institutions use UV light sources and specialized filters to quickly determine the legitimacy of banknotes. Photoluminescence techniques are used to identify and visualize bloodstains that might not be easily visible under normal lighting conditions. Luminol is a common chemical used in forensic investigations to detect latent bloodstains. When luminol reacts with the iron in hemoglobin, it produces a chemiluminescent reaction, emitting a blue glow that allows investigators to find hidden blood evidence. In forensic toxicology, photoluminescence can be employed to identify and quantify drugs or drug-related compounds. Some drugs fluoresce under specific wavelengths of light, making it easier for forensic scientists to detect and analyze them in biological samples.

(d) Use of X-rays

X-rays play a vital role in crime investigation and forensic analysis due to their ability to penetrate various materials and produce detailed images of hidden structures. X-rays are used to examine firearms, bullets and ammunition. Forensic experts can obtain X-ray images of weapons to identify their make and model, inspect serial numbers and detect modifications or alterations. X-ray radiography is also employed to examine fired bullets, bullet fragments and casings, providing crucial information in ballistics analysis. X-rays are employed in the examination of questioned documents, especially when there are concerns about concealed writing, alterations, or the presence of hidden information. By passing documents through an X-ray scanner, investigators may be able to detect hidden layers or reveal overwritten text. X-rays are used to inspect packages, baggage and containers for concealed drugs, weapons, or other contraband materials at border crossings, airports and customs checkpoints. X-ray scanners can reveal anomalies or hidden compartments that may contain illicit substances or smuggled goods. X-rays are used in forensic pathology to identify and analyze skeletal remains in cases where human remains are decomposed or partially skeletonized. This helps in determining the identity of the victim, any signs of injury, or potential causes of death.

(e) Facial Reconstruction through Software-Based Imaging Techniques

Software-based imaging methods for facial reconstruction are advanced techniques that utilize computer software and algorithms to create facial representations of individuals, particularly when the identity of the person is unknown or needs to be reconstructed from skeletal remains. These methods are commonly used in forensic anthropology, archaeology and criminal investigations. Here are some of the software-based imaging methods for facial reconstruction:

- **3D Facial Reconstruction Software:** This type of software uses 3D modeling techniques to create a three-dimensional representation of a face. It can take into account the individual's gender, age and ancestry to produce a more accurate and realistic reconstruction. The software can work with CT scans, MRI data, or 3D scans of skulls or skulls fragments, allowing forensic experts to create facial approximations from skeletal remains.

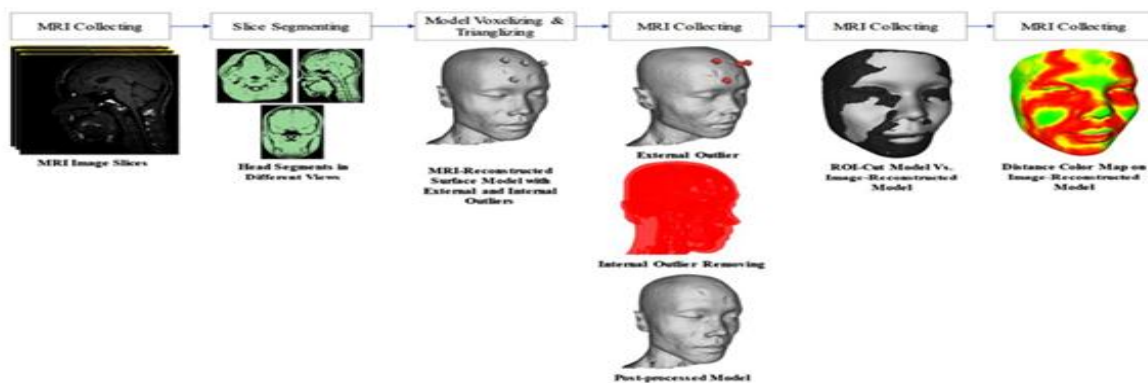

Figure 4: Reconstructed 3D face shape from the MRI images and segmentation.

- **Photogrammetry**

Photogrammetry involves the use of photographs taken from different angles of a skull or face to create a 3D model. Specialized software analyzes the images and constructs a digital representation of the facial structure. By incorporating tissue depth markers, the software can then add facial features and soft tissue to complete the reconstruction.

- **Feature-Based Facial Reconstruction Software:** This type of software relies on a database of facial features, such as eyes, nose, mouth and ears, captured from actual living individuals. When dealing with skeletal remains, the software matches the skeletal features with the closest matches in the database to reconstruct the facial appearance.

(f) Measurement of density

Density measurements are valuable in examining both soil and glass in forensic investigations. These measurements provide critical information about the physical properties of these materials, aiding in the comparison and analysis of evidence in criminal cases.

Density measurements of soil samples collected from different locations can reveal variations in the composition and structure of soils. This information can be used to link soil evidence found at a crime scene to a specific location, such as a suspect's property or a vehicle involved in the crime. Density measurements can help determine the degree of soil compaction, which is essential in hit-and-run investigations or cases involving buried evidence. Differences in soil density can indicate the presence of disturbed areas.

Density measurements can help differentiate between different types of glass, such as float glass, tempered glass, or laminated glass. Each type of glass has distinct density values due to variations in composition and manufacturing processes. In hit-and-run cases or cases involving broken glass objects as weapons, forensic experts may compare the density of glass fragments found on the suspect's clothing or vehicle to glass samples from the crime scene to establish a connection.

(g) Utilizing Refractive Index and Birefringence in Fiber Analysis

In crime investigation, refractive index and birefringence are valuable properties used in fiber analysis to identify, characterize and compare fibers found at crime scenes or on suspects. Fiber evidence is often encountered in cases involving crimes like assault, abduction, sexual assault, burglary and hit-and-run incidents.

When fibers are collected from crime scenes or suspects, forensic scientists measure their refractive indices. By comparing the refractive index values to reference databases or known fibers, investigators can determine the type and origin of the fibers, providing important clues in narrowing down suspects or establishing links between individuals and crime scenes.

Birefringence is observed under polarized light microscopy, where the fibers are placed between crossed polarizers. Birefringent fibers display characteristic interference patterns, leading to the appearance of different colors or patterns. This allows forensic scientists to distinguish birefringent fibers from isotropic materials and aids in fiber identification. Birefringence can be used to match fibers found on a suspect's clothing or belongings with fibers recovered from the crime scene. If fibers exhibit similar birefringence patterns, it strengthens the link between the suspect and the crime location.

An **offense** refers to any act that causes harm to others, disrupts the peace within a community, or involves acts of aggression towards the State. This pervasive issue takes on various forms, including those directed against individuals' bodies, acts of terrorism and threats to the State, crimes against property, offenses targeting women and children, as well as disturbances to public order and tranquility. In India, the Indian Penal Code of 1860, a relic of the British era, encompasses provisions dealing with diverse offenses. Post-independence, the IPC underwent numerous amendments, constantly evolving to incorporate new sections addressing a wide array of offenses. Offenses display a dynamic and multifaceted nature, prompting varying perspectives among scholars on their classification. Based on the criteria employed, offenses can assume distinct types. Broadly, offenses are categorized into the following types:

1. **Offences against Human Body:** The Chapter XVI of the IPC, 1860, contains offences against human body from Section 299 to 376. Some of them are Murder (Section 300), Dowry Death (Section 304 B), Attempt to Murder (Section 307), Thug (Section 310), Concealment of Birth by Secret Disposal of Dead Body (Section 318), Criminal Force (Section 350), Assault (Section 351), Kidnapping (Section 359), Abduction (Section 362) etc.
2. **Offences against State and Terrorism:** The Chapter VI of the IPC, 1860, contains offences against State from Section 121 to 130. Some of them are Concealing with Intent to Facilitate Design to Wage War (Section 123), Seditious Speeches (Section 124-A), Public Servant Voluntarily Allowing Prisoner of State or War to Escape (Section 128), Public Servant Negligently Suffering Such Prisoner to Escape (Section 129), Aiding Escape of Rescuing or Harboring Such Prisoner (Section 130) etc.

3. **Offences against Property:** The Chapter XVII contains sections regarding offence against property. Some of them are Theft (Section 378), Extortion (Section 383), Robbery (Section 390), Dacoity (Section 391), Dacoity with Murder (Section 396), Criminal Breach of Trust (Section 405), Stolen Property (Section 410), Cheating (Section 415), Mischief (Section 425), Criminal Trespass (Section 441) etc.
4. **Offences against Women and Children:** The Indian Penal Code (IPC) addresses a wide range of offences that specifically pertain to women and children. They are covered in different chapters.
 - Important Sections regarding Offence against Women are Voluntarily Throwing or Attempting to Throw Acid (Section 326B), Assault or Criminal Force to Woman with Intent to Outrage her Modesty (Section 354), Rape (Section 375), Sexual Intercourse by Husband upon his Wife during Separation (Section 376B), Gang Rape (Section 376D), Sexual Harassment (Section 354A), Stalking (Section 354D), Importation of Girl from Foreign Country (section 366B), Word, Gesture or Act Intended to Insult the Modesty of a Woman (Section 509) etc.
 - Some Important Sections regarding Offence against Children are Section 315 of the Act (Act done with intent to prevent child being born alive or to cause it to die after birth), Kidnapping or Maiming a Minor for Purposes of Begging (Section 363A), Procurement of Minor Girl (Section 366A), Selling Minor for Purposes of Prostitution, etc. (Section 372), Buying Minor for Purposes of Prostitution, etc. (Section 373) etc.
5. **Offences against the Public Tranquility:** The offences against the public tranquility are mentioned in Chapter VIII of the IPC Section 141 to 160. Some of them are Unlawful Assembly (Section 141), Rioting (Section 146), Assaulting or Obstructing Public Servant when Suppressing Riot, etc. (Section 152), Promoting Enmity (Section 153A), Harboursing Persons Hired for an Unlawful Assembly (Section 157), Affray (Section 159) etc.

Various crimes that occurred in **Ranchi** over the last five years, retrieved from the District Police Office:

Crime Head	2018	2019	2020	2021	2022
Murder	186	175	167	186	168
Dacoity	14	15	10	07	03
Robbery	98	200	221	166	157
House Burglary	363	390	375	415	439
Theft	2486	2358	1767	1902	2377
Riot	122	113	100	75	74
Kidnapping	208	221	208	194	218
Rape	179	191	231	206	190
Arms Act	108	84	89	92	85
Explosive Act	02	01	04	03	04
Naxal Cases	25	24	23	23	28
Other(Misc.)	4297	4944	4925	4647	5267

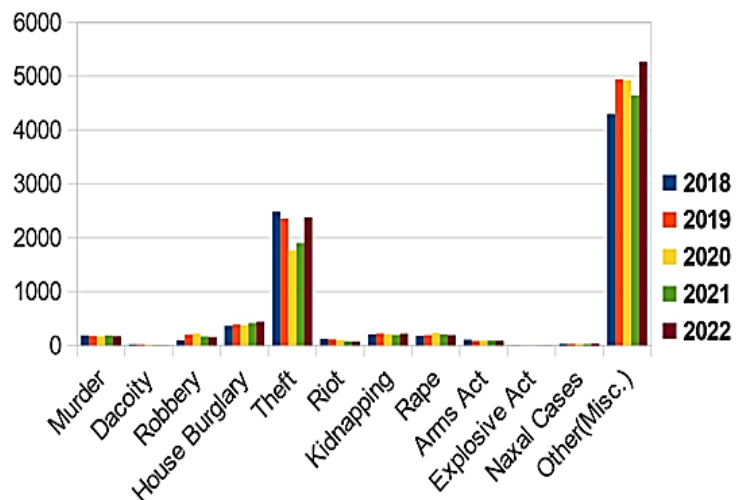

Table and Graph for Incidents of crime occurred between the years 2018 and 2022.

Based on the graph above, we can draw several conclusions. Theft is the most frequently reported crime, followed by house burglary and kidnapping. Murder cases appear relatively consistent across all years. House burglary exhibits a gradual increase over time. The theft graph displays a U-shaped tendency, indicating a decline initially, followed by an increment from the year 2020 onwards.

In conclusion, the integration of physics into forensic science has revolutionized the field of criminal investigation and analysis. Physics principles and methodologies have proven to be indispensable tools for forensic scientists in unraveling complex crime scenes, identifying evidence and providing critical insights into criminal activities.

Through ballistics analysis, forensic experts can precisely determine the trajectory of projectiles, shedding light on shooting incidents and firearms-related crimes. The application of spectroscopy and chromatography in forensic chemistry allows for the accurate identification of substances, including drugs and poisons, leading to a deeper understanding of crime-related materials.

By combining the scientific knowledge of physics with artistic skills and anatomical expertise, forensic facial reconstruction provides law enforcement and forensic investigators with a powerful tool to help identify unknown individuals and provide closure to families of missing persons.

Physics also plays a crucial role **in bloodstain pattern** analysis, helping investigators recreate crime events and deduce valuable information about the dynamics of violent acts. In digital forensics, physics-based techniques facilitate the retrieval and validation of digital evidence, ensuring its admissibility and authenticity in court.

Moreover, the use of physics principles enables forensic photographers to capture precise and comprehensive crime scene documentation, preserving crucial details that may prove decisive in solving cases. Accident reconstruction benefits from physics-based methodologies, aiding in the understanding of collision dynamics and contributing to the prevention of future incidents.

Additionally, forensic anthropology leverages physics to estimate time since death and interpret skeletal trauma, enhancing the ability to identify victims and reconstruct past events accurately. Firearms and tool mark examination, through the study of material properties and deformation, assists in linking suspects to weapons and tools used in criminal activities.

Overall, **the fusion of physics and forensic science** has led to more objective, accurate and scientific investigations. As technology advances, the integration of physics in forensic science will continue to evolve, ensuring that the pursuit of justice remains steadfast and unwavering in the face of complex criminal challenges. With ongoing research and development, the future of physics in forensic science holds the promise of further innovations, strengthening the criminal justice system and safeguarding society from harm.

PHYSICS IN FORENSIC SCIENCE

Mizan Alvi

SMS Dutta Memorial Nosegay Public School, Khatima, Udham Singh Nagar, Uttarakhand

Keywords: Criminalistics, Radioactive Ray, Blood Splatter, Trace Evidence, Facial Reconstruction.

Forensic science is the application of scientific methods and techniques to matters under investigation by a court of law. Forensic science technicians work at crime scene investigations and are responsible for gathering and analyzing evidence. They may take photos and keep written records of crime scene evidence. Forensic science, also known as criminalistics, is the application of science to criminal and civil laws. During criminal investigation in particular, it is governed by the legal standards of admissible evidence and criminal procedure.

Indirectly, physics has contributed to forensic science via the invention of the microscope, the electron microscope, the mass spectrometer and optical spectrometers; but directly, its role in forensic science has been minimal.

The crime sciences under the department of forensic scientists are using physics to solve or to prevent crimes. Physics can be applied in different ways. Forensic evidence and physical evidence provide most of the era in which forensic expert (Physics), also known as scientists, can explain his/her expertise with using fundamental physics. Forensic physics has traditionally involved the measurement of density (soil and glass examination), index of refraction and birefringence (fiber analysis, glass examination).

In the last 25 years, the use of the photoluminescence phenomenon for physical evidence examination has emerged, with latent fingerprint detection the most notable application. In criminalistics, fingerprint detection is important because it provides absolute identity and does not suffer from the contamination problems to which DNA profiling is prone. Fundamental physics having a great contribution in the field of forensic science via ray optics, laser sources and modern physics and many more. Instrumentation like optical microscope, the electron microscope, the mass spectrometer and optical spectrometers (optical physics); but directly, physical sciences role in forensic science has been used. Forensic physics in crime labs have been traditionally involved the measurement of density (soil and glass examination), index of refraction and birefringence (fiber analysis, glass examination), restoration of VIN, Building material analysis etc.

The Physics Forum of the November 1938 issue of the Review of Scientific Instruments is devoted to an account of the use made of physics in the detection of crime in the United States. It is written by J. Edgar Hoover, of the Federal Bureau of Investigation of the Department of Justice. Although the author refers to the use of radio in rapidly communicating information, the account is mainly concerned with optical methods: the microscope for the identification of hair, shreds of clothing or other small particles, for the examination of minute markings on bullets so as to identify the weapon used, or the markings on a cut window bar to identify the bolt cutter used and with the addition of polarizing prisms, the identification of soil stains on shoes or clothing. The spectroscopy is used for identification of stains of all kinds, ultra-violet light for the identification of materials by their fluorescence, for the detection of erasures in documents or for reading documents written in secret ink invisible in ordinary light. X-rays are used for the examination of suspected parcels without opening them and infra-red light for reading obliterated writing or printing on paper and other materials.

Physics can be used to detect crime through radioactive rays i.e. ultra-violet light. The ultra-violet light is a form of radiation that is not visible to the human eye. Ultra-Violet light is recommended by the Federation Bureau of investigation (FBI) for investigation and is often used in forensics to reveal bodily fluids such as: blood, saliva and semen. Because of its ability to reveal things that are not



visible to the human eye, it is also called an ALS (alternate light source). Forensic scientists use reflective ultraviolet imaging system to find fingerprints. The reflective ultraviolet imaging system consists of a ray of Ultra-violet light that must be positioned in a proper angle onto the surface that has suspected prints. RUVIS devices use 254nm UV light. The angle of the light beam is important because the light must only scatter and reflect the image of the print so that the ridges are seen in contrast of the background. Ideally, prints should be illuminated in contrast of the background, instead of the other way around. Fingerprints are important pieces of evidence

because every single person has their own unique print. When crime scene investigators find fingerprints using UV light, they are able to search the print within a special database which holds all of the fingerprints of citizens in India.

Not only ultra-violet light is the only radioactive ray which is used in crime detection but also x-rays are used in crime forensic. Forensic radiologists help to solve and prevent crimes, determine causes of death and confirm the identities of victims especially in mass casualty incidents such as plane crashes. They use X-rays to locate hidden characteristics of a victim, such as a broken bone or hip replacement that could help to identify him; in addition, they can sometimes identify what kind of weapon caused the injury. They also assist in assault and child abuse cases. For example, if a child is taken to the hospital with reported accidental injuries, a forensic radiologist can sometimes look at X-rays to determine whether the injuries could have occurred in the way they were reported. Or, he may evidence of previous injuries, suggesting a pattern of abuse. The field evolved shortly after the discovery of X-ray technology in 1895 and was first used to convict an accused murder in America, quickly spreading to other countries (Ellie Williams, 2010).

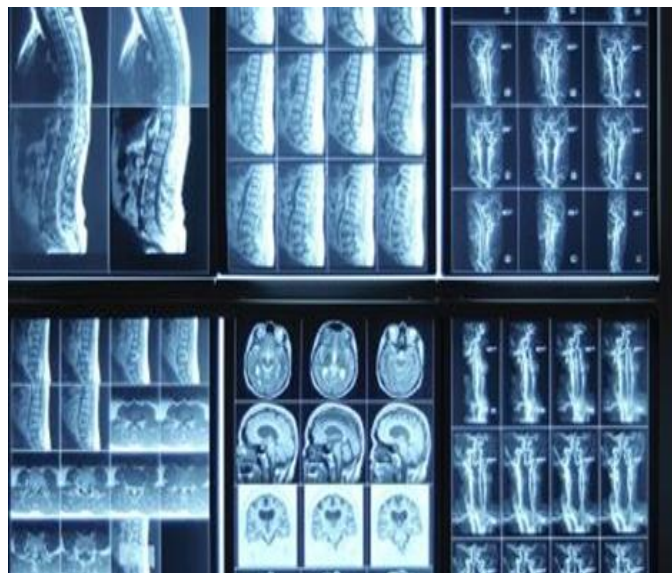

Another radioactive ray that is used for crime detection is infra-red light. A distinction is made between applications using passive and active infrared imaging. Passive infrared imaging can be used

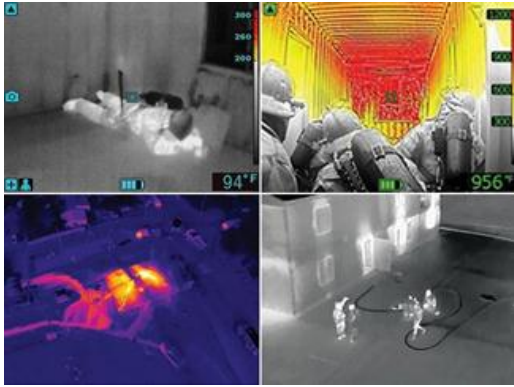

to investigate heat traces, which cause contrast because of temperature differences. Active infrared imaging can be used to visualize differences in thermal response, using an external heat source. Because the human body temperature is usually higher than the environmental temperature, people leave heat traces invisible to the human eye, which can be observed with an infrared camera. Consequently, infrared imaging can give insight in the recent presence of people and recently handled objects. As it is frequently possible to obtain

DNA from an individual who has simply touched an object, this is highly important information supporting crime scene investigators in their search for trace evidence. Additionally, information about the presence of people and recent activities is useful for crime reconstruction purposes and for the verification of statements.

In addition to radioactive rays, physics is also used in Gun ballistics; it is the work of projectiles from the time of shooting to the time of impact with the target. Gun ballistics uses physics to help find the path of the bullet, height the gun was shot and speed of the bullet. This information can be used to find the guilty criminal. Gun ballistics is often broken down into the following four categories. Four categories are:

Internal ballistics (sometimes called interior ballistics): treats of the motion of a projectile while it is still in the gun, for example the passage of a bullet through the barrel of a rifle.

Transition ballistics (sometimes called intermediate ballistics): the study of the projectile's behavior when it leaves the barrel and the pressure behind the projectile is equalized.

External ballistics (sometimes called exterior ballistics): the study of the passage of the projectile through a medium, most commonly earth's atmosphere. Considers the motion of the projectile from the time it emerges from the gun until it reaches the target.

Terminal ballistics: the study of the interaction of a projectile with its target terminal. It deals with the effect of the projectile on the target.

Furthermore, physics is also used in using the laws of physics in Blood Splatters, the shape of the blood spatter is mostly used to determine the size of the hole the blood is forced through. With a smaller hole, the stream will be more powerful, but the spatter size will be smaller. This helps determine the size of the wound. Size of spatter is similarly very useful. For one, blood, like all objects, picks up speed as it falls. Unless it is from a fall above 26 feet, blood's terminal velocity, investigators can pinpoint from what height it fell. This is useful, for example, when trying to determine whether a person was standing or lying down during an attack. Investigators can also judge the energy used to force the blood into flight. This can help tell how forceful the strike was. The higher the energy used, the smaller the dots of blood will be. It is also possible to judge from which direction the strike came, by calculating the angle of the blood's impact using trigonometric formulas. There are three types of blood stain patterns:

- **Passive bloodstains:** blood drops falling with only the force of gravity acting upon it.
- **Projected bloodstains:** when some form of energy is transferred to the blood splatters.
- **Transfer/ contact bloodstains:** when an object with blood comes in contact with object without blood.

The velocity of the blood splatter effects the stain it creates. Low velocity blood splatter is produced when the blood is moving less than 1.5 m/s, Medium velocity blood splatter is produced when blood is travelling between 1.5m/s and 7.5 m/s (blunt force trauma), High velocity blood splatter is observed when blood is travelling more than 30 m/s. Using the velocity of the blood and shape of the blood, physics and math can be used to determine the height, direction and magnitude of the blood.



Another way how physics can be used is in investigating car crash. Car collisions happen every day and sometimes they are fatal. In some cases, where the police don't have video tape of the car crashes or witnesses, they rely on physics to figure out who was responsible for the car crash. Physics behind the car crash, this type of collision usually results in the biggest momentum forwards for passengers in the car, due to the sudden stop in forward momentum of the cars. The upper bodies of passenger(s) are jerked forward while the lower body is anchored to the seat, because of the lower end of the seat belt, which is usually more secure. The force with which the body is thrown forwards depends on two factors: the combined speed at impact and the hardness of the car body. The greater the speed of the



car on impact, the greater the force acting on the car passengers and hence the more they jerk forward. Also, if the car body is made of very hard metal, then it would crumple less and hence the time taken for the whole car to come to a complete stop would be very short. Since time is decreased, then the rate of deceleration of the car would be very fast and hence a greater force acting on the passengers, jerking them forward, because:

Force = Mass X Acceleration; or in this case, Opposite Force (of the car) = Mass X Deceleration (of the car). The bodies of the passengers will jerk forward because, with the car's initial cruising speed, both the car and the passengers are moving at a constant speed forward. During collision, the car's speed is slowed down very quickly, leaving the passengers to continue in the forward direction, hence their jerking motion. All the forces present in a head-on car collision are generally linear and hence the physics behind it isn't too hard.

Side Collisions, in such a scenario, passengers in a stationary car are first thrown towards the side of the collided vehicle because of the sudden displacement of the car (i.e. side-ways momentum). After this, passengers are usually thrown into the opposite side of the car because of the decrease in initial side-ways momentum their car has experienced. The car which started the accident, i.e. the one which collided into the stationary car, would experience the same forces as a head-on collision. Side airbags would be of the most use for the initially-stationary car, while front airbags would be of most use for the other car.

The amount of force that causes an accident is largely dependent on Newton's 2nd and 3rd laws, i.e. $F=MA$, and For every action, there is an equal and opposite reaction, respectively. Newton's 1st law, Every object in a state of uniform motion tends to remain in that state of motion unless an external force is applied to it, explains why passengers in cars are thrown about in a collision, which usually

results in a sudden acceleration or deceleration. Factors that affect the degree of damage to the car and injury to passengers are the hardness of the car body, the initial cruising speed of the car, angle of collision (from where does the car impact on to), the design of the car, the weight of the car, body mass and position of the passengers of the car.

Harder the car body, the greater the rate of acceleration or deceleration on the whole car. A greater acceleration for the same mass results in greater force ($F=MA$), which would mean passengers of the car would be subject to more violent jerking and might possible sustain more injury, even though the car would have less damage. Likewise, the softer the car body, the more damage the car would sustain. This would mean the car body would crumple up more and as lower rate of acceleration or deceleration on the whole for the car, resulting in less violent jerks of passengers, meaning less chance of injury. Of course, if the car were too soft, passengers would be crushed to death by the impact.

The faster the initial cruising speed of the car, the greater the impact felt. This is explained by 3rd law. If a car were to crash into a brick wall, the brick wall would exert an equal and opposite pressure on the car, which is what causes the car to crumple up and throw the passengers about. For a slower initial cruising speed, the less the force acting on the brick wall and since an equal and opposite reaction is acted on the car, the lesser the force crumpling up the car.

The greater the weight or mass of the car, the greater the forces dealt. This is because of $F=MA$, meaning if the car crashing into a stationary car were very heavy as compared to the stationary car, the stationary car could be sent flying. However if the roles were reversed and the car crashing into the stationary car were much lighter than the stationary car, the stationary car would not sustain much damage.

Forensic facial reconstruction can be used to identify unknown human remains when other techniques fail. There are several techniques of doing facial reconstruction, which vary from two dimensional drawings to three dimensional clay models. With the advancement in 3D technology, a rapid, efficient and cost effective computerized 3D forensic facial reconstruction method has been developed which has brought down the degree of error previously encountered. There are several methods of manual facial reconstruction but the combination Manchester method has been reported to be the best and most accurate method for the positive recognition of an individual. Recognition allows the involved government agencies to make a list of suspected victims. This list can then be narrowed down and a positive identification may be given by the more conventional method of forensic medicine. Facial reconstruction allows visual identification by the individual's family and associates to become easy and more definite.

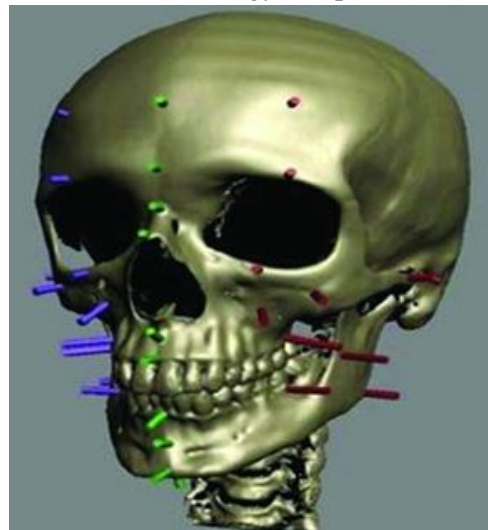

The field of forensic investigation is of increasing importance and thus the role of the Scanning Electron Microscope (SEM) becomes progressively more significant. Due to its ability to examine detail on a wide range of materials in an easily interpreted manner, from high to low magnification with an exceptional depth of focus, the SEM has become an indispensable tool. Together with the ability to analyze the elemental composition of even the smallest features on specimens, it becomes

possible to make conclusive identifications of the origin of some materials and thus contribute to the chain of evidence.

Due to its superior performance the SEM is used in an increasing number of various applications and provides valuable results for instance in the following applications:

- Gunshot residue analysis
- Firearms identification (bullet markings comparison)
- Investigation of gemstones and jewellery
- Examination of paint particles and fibres
- Filament bulb investigations at traffic accidents
- Handwriting and print examination / forgery
- Counterfeit bank notes
- Trace comparison
- Examination of non-conducting materials
- High resolution surface imaging



Mass spectroscopy, also called mass spectrometry, is a scientific method that analyzes a sample of

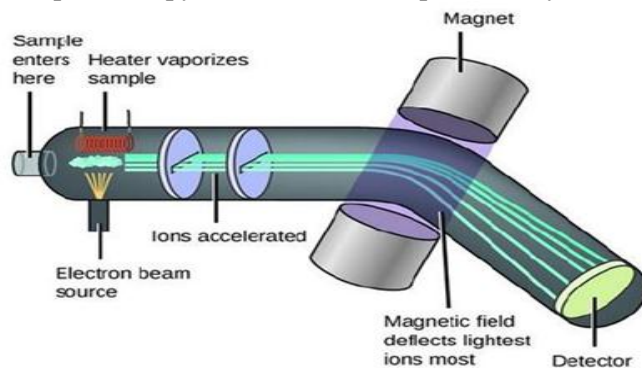

material to determine its molecular makeup. By ionizing a sample, a scientist can cause it to separate into its individual ions. This allows him to analyze and categorize those ions to determine the sample's composition. Mass spectrometry has become a valuable tool in forensic science, where it can provide clues from the barest traces left by a suspect.

Toxicology Analysis: One area where a mass spectrometer is handy is in cases involving poisons or toxins. Forensic analysts can take samples of a subject's tissues or bodily fluids and determine if any toxic substances are present and if so, in what concentration. This can give vital clues to investigators as to how a victim died as well as help identify the time and dosage of any poison or medication ingested. Investigators can also determine if a victim was a regular user of any substances that might have contributed to his or her death.

Trace Evidence: Mass spectrometry is also useful in analyzing trace evidence. Investigators at a crime scene may find microscopic materials like carpet fibers, glass splinters or paint flakes. Ordinarily, these substances might be extremely difficult to use as a starting point to identify a suspect. However, a mass spectrometer can determine the precise mix of dyes used in carpet fibers, the makeup of materials that went into any particular glass fragment and the precise set of polymers present in any paint sample. This information can lead investigators to a particular manufacturer, who may be able to narrow down where a given sample came from, helping detectives to identify suspects and build a case.

Arson Investigations: Arson investigations can also benefit from the use of mass spectrometry. While an arson investigator might be able to identify the use of an accelerant through burn patterns or

lingering odors, a mass spectrometer can break down any residue and provide an accurate report of its molecular makeup. This can help identify any unique or exotic compounds that may be present. Discovering a similar mix used at multiple crime scenes may be useful for identifying the work of a serial arsonist.

Explosive Residue: Another area where spectrographic analysis is extremely useful is in analyzing explosive residue. When a bomb detonates, it may not leave behind much in the way of physical

evidence -- perhaps only small fragments and chemical residues. However, commercial explosive manufacturers each utilize their own unique mix of chemicals and a spectrometer can analyze this residue to identify the particular makeup of the explosive involved. Even in cases where a bomber used a homemade mix, the analysis may identify the type of materials used and give investigators a push in the right direction to identify the source.



Forensic Soil Analysis is the use of soil sciences and other disciplines to aid in criminal investigation.

Soils are like fingerprints because every type of soil that exists has unique properties that act as identification markers. This means that the origin of the soil sample can be identified. For example, clay embedded in the sneaker of a criminal can be traced back to a specific clay type found along a lake where a murder victim was discovered. The majority of soil cases involves footprints of tyre



marks that have been left in the soil. The unique properties of soil are Sediment, Color and Structure.

Forensic glass analysis is the application and analysis of glass to determine details about a crime. Glass evidence comes in many forms in various types of criminal cases. Glass can be analyzed to understand its origin using comparative analysis which may include measurements relating to physical match, refractive index, density and elemental analysis. It is also possible to analyze glass fractures to better understand the angle, direction and sequence of force as well as the projectile used. Depending on the form of the evidence, glass analysis can be collected in several ways. When possible, it is preferred that the entire item of evidence, such as a glass fragment or sweater with glass shards, is collected. Glass evidence can also take on the form of trace evidence. In these cases, trace evidence lifters, forensic vacuums or tweezers can aid in the collection of the glass evidence. Small glass fragments or shards can be secured in a pharmacist's fold and in an envelope. It is also important that the location from where the glass was recovered is noted. When it is suspected that an individual has small glass fragments on their person, their hair can be combed and caught on examination paper

in an attempt to recover potential glass fragments. In addition to combing the hair, the individual can remove their clothes on examination paper which can then be sealed and saved for examination at a later time.

As per the data collected from the government hospital, Khatima; total cases came to the hospital in the last five years are as under:

YEAR	NO OF CASES
2019	1012
2020	1018
2021	572
2022	496
2023 (Till July)	378

We can see more cases in 2019 and 2020 due to corona pandemic. After the decrease in the cases from 2021 to 2022 again we have seen increase in the cases in 2023.

Data collected from Khatima Police station has the following statistics:

YEAR	NO OF CASES REGISTERED
2019	512
2020	598
2021	336
2022	381
2023 (Till July)	318

According to the sources, there is increase in the road accident cases.

A recent innovation in some physics departments is the introduction of courses on forensic physics. In the Physical sciences for forensic person the topics of interest include road accidents analysis; firearm and bullets profile analysis, fire, arson and explosion investigation, materials identification (fake jewellery etc.) and software-based imaging methods for facial reconstruction etc. Another topic that could be used to illustrate a forensic application of Newton's laws, momentum conservations laws and blood pattern analysis using trigonometry and the physics of falls from a height involving serious injury or death. General Physics in forensic science involves electrical, mechanical, chemical and laboratory analysis as well as mathematical formulations based on recognized principles of fundamental physics. The fundamental physics like conservation law of momentum, collision, Newton's law of motions are having a great and vital application in reconstruction of scene of crime. All the fundamental laws of Physics are very much helpful to analyze the evidence as well and draw any conclusion.

PHYSICS IN FORENSIC SCIENCE

Akshay Shankar

Calorx Olive International School, Ahmedabad

Key words: Forensics, Radioactivity, Total internal reflection, Density and force, Blood dynamics.

The Need for Forensics

The 20th century marks the age of science, in which the highest rate of scientific progression has occurred. Forensics plays a crucial role in this 20th century/modern society, bringing in accurate and reliable investigations and analysis of crime scenes, bringing fair justice to society. The first center of a forensics sciences division to be established in India was the fingerprint bureau of India which was established in Kolkata in the year 1897 and was in operation in 1904. This marked the beginning of forensics in India. Even before modern society and forensic sciences existed in any part of the world, a primary level of forensics was used. For example, around 1325 in the Chinese provinces, a Chinese farmer was murdered in his field with a sickle and the Individual who slayed the farmer was to be found and punished. The authority laid out the tools belonging to all farmers present. After which, the presence of blood was tested by letting all of them dry and noticing which weapon had flies covering them. This proves that one of the possible owners of the weapon is indeed guilty. However, there is still no way to prove that an Individual used that weapon. Hence forensics has expanded to a science, bringing in methods to identify fingerprints and many more techniques. This provides higher accuracy in convicting Individuals and or finding the source of an incident in an ever-growing society and an ever-growing complexity in cases. Now forensics continues to advance alongside the growing complexity of criminal activities and technology. This has led to several divisions in forensics: biology, chemistry, ballistics and digital forensics, but most of these divisions focus on identifying physical evidence through scientific means.

An example of this is *isotope dating*. Individuals using samples of their hair, seeing the difference in the proportionality of carbon and oxygen isotopes, allowing for a complete record of all nations visited by an individual depending on the length of their hair. Another example would be the usage of *chromatography* in arson incidents and toxicology. *Gas chromatography-mass spectrometry* can be used on the residue left on objects to gather critical evidence in arson incidents and chromatography can be used on samples of skin, tissue, urine and blood to gather evidence on cases regarding drug overdose or assassinations through toxins.

Forensic ballistics

Ballistic forensics analyzes the evidence related to firearms and projectiles in criminal investigations. The field requires identifying and comparing firearms, their respective trajectories and examining the residue left behind one of the ways ballistic Forensics experts bring value to the evidence discovered at the crime scene. For example, the footprints on the terrace

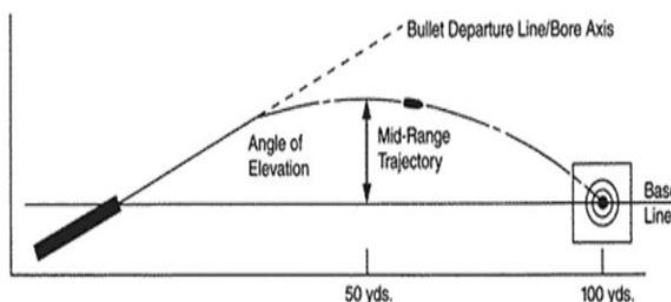

of a building would not be of importance until a ballistics forensics expert can identify the angle at which a possible shooter could aim and the likely speed of the bullet by using two formulas. The first formula would be:

$$s = \frac{d}{t}$$

The speed of the bullet can be found by possible camera footage (an expert can determine the approximate speed either way with or without a time based on the caliber of the bullet), showing the time elapsed for the flare of the gun and the impact site. Then by measuring the distance from the shooting location and the impact site using a measuring wheel, which is used to roll along the ground, its rotations are translated into distance measurements. Then by solving this equation, the speed of the gun can be derived and the speed can also be approximated by an expert who can identify the firearm and caliber of the bullet. Finally, this value can be used as velocity in the formula of maximum horizontal range.

Then using the formula for horizontal range when launching a projectile from an elevated position (when initial height is greater than 0):

$$R = \frac{v_0^2 \sin 2\theta}{g}$$

R is the horizontal distance, v_0 is the bullet's velocity, and g is the gravitational acceleration. This equation provides the required information to reconstruct shooting incidents, identify possible shooter locations and single down evidence. Ballistic forensic experts use trajectory rods, or trajectory rod assemblies, to determine the angle at which a firearm is shot.

Forensics spectrometry, radiation and dating

Material science is the usage of scientific techniques to provide a comprehensive view and approach to the study of materials used in solid-state physics and or quantum chemistry. Most of it includes methods that employ non-destructive interactions, such as radiation analysis. One such application is X-ray fluorescence (XRF), which can be used to identify the elemental components of a compound based on the secondary radiation emitted by that material after having electrons excited with high-energy X-rays, this entire process leaves the sample unaffected on a chemical and physical level after

examination as it does not destroy the atoms. XRF can help settle or dismiss a criminal investigation, providing non-destructive element analysis of trace evidence, such as paint chips on opposite cars, gun residues and more. The evidence gathered from this process plays a critical role in forensic investigations by providing valuable insights into the origin, association and significance of evidence, aiding in identifying and resolving criminal cases. The majority of forensics departments utilize a micro-XRF which can identify elements in compounds within any prep, these micro-XRF use ED-XRF, which is energy dispersing x-ray fluorescence, in which an x-ray sample excites the sample to be analyzed and a sensitive measurement device with thousands of channels to absorbs the x-rays emitted by the excited samples creates a spectrum of the element present in the sample. Radiocarbon dating is another area where radiation is utilized in forensics. This technique allows for estimating the age of organic materials, such as bones or textiles. By measuring the decay of the radioactive isotope carbon-14, forensic scientists can determine the time of death or the age of an unidentified body.

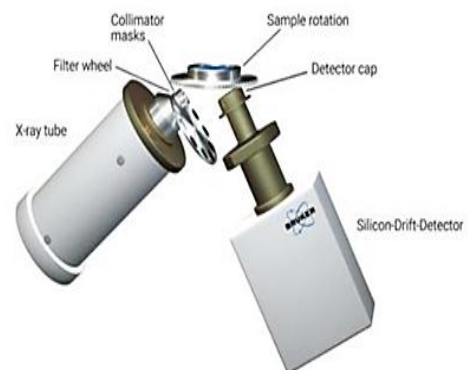

Carbon-14 has a half-life of 5730 years and a decay constant of 0.000121 per year:

$$\text{age of sample} = \frac{\ln\left(\frac{N_0}{N}\right)}{\lambda}$$

Where N_0 is the initial amount of C-14 atoms in a sample, determined by an expert in approximation and N is the final amount of C-14 atoms and λ is the decay constant. Given a sample of bio-matter of 80000 C-14 atoms and a suggested approximation of this sample could have been 100000 C-14, the formula shows:

$$\text{age of sample} = \frac{\ln\left(\frac{100000}{80000}\right)}{0.000121}$$

$$\text{age of sample} = \frac{0.22314355}{0.000121}$$

$$\text{age of sample} = 1844.1615 \text{ years}$$

Age approximately equals 1844.1615 years, giving a predicted age to a sample and proving relevance to a case.

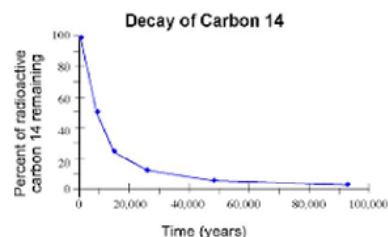

Forensics chemistry, biology, toxicology and drug analysis

Within the fields of chemistry, biology, toxicology, and drug analysis, the most powerful physics analysis apparatus is the mass spectrometer. The mass spectrometer takes in compounds and ionizes them, after which it is vaporized and accelerated through charged plates. A strong magnetic field is induced, deflecting the lighter ions of the compounds greater, creating a scale of the compound's mass or element's mass with respect to its abundance. This scale can be created using a quadrupole, time-of-flight, ion trap and magnetic sector analyzers. Each mass analyzer applies a different principle to separate the ions based on their masses. Different ionization techniques can be utilized based on the nature of the sample, such

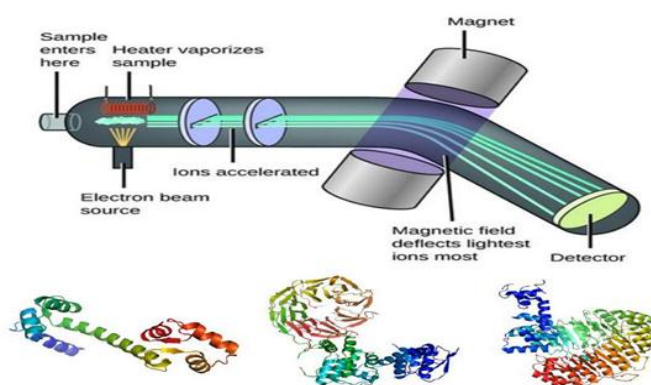

as impact ionization, electrospray ionization and matrix-assisted laser desorption/ ionization. With specification to chemical compounds, the obtained mass spectrum, compared to a database containing a known mass of spectra of various compounds, can allow conclusions to be made based on evidence of soot from arson incidents, poisons, or acid. Similarly, mass spectrometry can use blood samples to find compounds within the blood to help narrow down the form of poison used on a victim. This concept can further branch into DNA identification. More specifically, it is used for proteomics, the identification of proteins in DNA. Proteomics can help compare and identify the relevance of bodily fluids in a crime scene by matching the proteins of the suspect and the scene of the crime. The mass spectrometer separates the proteins in the body fluids sample and can help to link the suspect's distinct protein composition. This can also provide specific markers which guide experts in investigating them under a microscope to help date the body sample, providing further information.

Forensics microscopy

Microscopes are essential tools in forensic investigations, as they have the ability to reveal critical details located in the environment of the crime scene, some of which may not be visible to the naked

eye. The microscopes enable scientists to establish the presence of evidence in fibers, hair, glass fragments, paint chips and gunshot residues, sometimes stretching as far as establishing the presence of biological markers in bodily fluids. The most frequently used microscope is the Scanning Electron Microscope (SEM), which exceeds the capability of the optical microscope, as the wavelength of light limits the resolution in an optical microscope. The SEM uses an electron gun to produce a stream of electrons, electromagnetic lenses are used to focus the stream of electrons and a detector is used to gather the interference pattern of the electrons. This pattern can be achieved by the electron interacting with matter in two main ways. The first measurable electron pattern is the secondary electron, where a low-energy electron is emitted by the surface of a sample when bombarded by electrons. The other measurable electron pattern is the backscattered electrons, which occur when electrons undergo elastic scattering when they interact with atoms in the sample. They get deflected back toward the detectors. Secondary electrons help experts to visualize the surface morphology of samples, and backscattered electrons help to visualize the atomic composition and contrast variations in a sample.

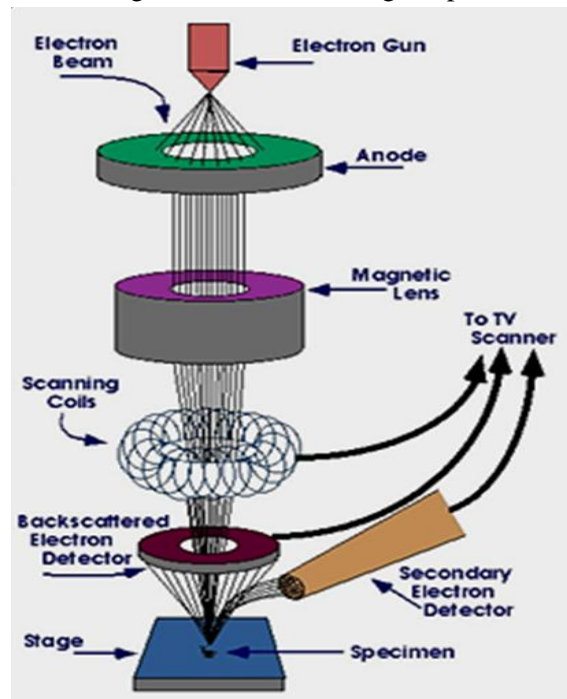

Forensics forces and speed

The first step of a forensics investigation is to collect evidence, then link those evidence together to form a coherent line of action that took place at the scene of an accident or crime. In the case of automobile incidents, the speed of the car must be identified when put into trial, hence the formula $S \cdot c \cdot l = 55$ is used to find the speed with the skid distance and coefficient of friction of the road to the tires. S is the speed in miles, c is the coefficient of friction, 55 is a constant and l is the length of skid marks. When derivative the following into metric units, we get the equation:

$$S = \frac{88.5137}{c \cdot (l \cdot 3.28)}$$

Forensic sciences can also employ the fundamental equation $F = ma$ to analyze and interpret physical evidence found at crime scenes. One application is in the reconstruction of accidents. Forensic experts utilize the principles of Newton's laws to reconstruct accidents by examining the damage caused to vehicles or objects involved. By assessing the forces involved and the resulting acceleration, they can estimate the speeds at which the vehicles were traveling. This information can be crucial in determining the sequence of events leading up to an accident. Additionally, these principles can be involved in injury analysis, especially when investigating cases involving physical assault or homicide. By examining the characteristics of an injury, such as its depth, shape and location, they can estimate the magnitude and direction of the force applied, aiding in the investigation and understanding of the events that took place.

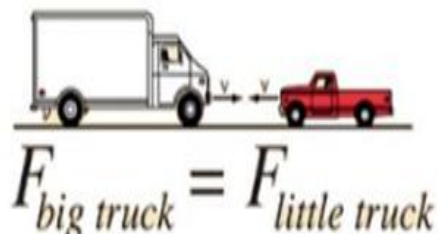

Forensics fall scene reconstruction

Understanding the positions of corpses at a crime scene can help to find further evidence from further locations. A great example would be the need to calculate the horizontal distance an Individual traversed before falling, this can lead back to a room in a building from which an Individual could have been possibly ambushed or held captive. This equation helps to identify if the reason of the fall could be linked to a convict or self-infliction.

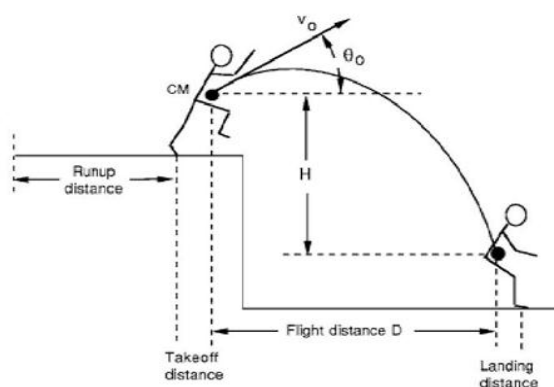

The horizontal distance can be calculated from the equation:

$$D = \frac{(v_0^2 \sin(2\theta_0))}{2g} \left[1 + \left(1 + \frac{2gH}{v_0^2 \sin^2 \theta_0} \right)^{\frac{1}{2}} \right]$$

Where D represents the horizontal, H is the vertical height, g is the earth's gravitational acceleration, and θ_0 is the launch angle (an estimated guess based on the maximum flight distance of 45, 25 and 15 degrees based on the elevation) and v_0 is the initial velocity or speed at which the individual ran before falling. Without camera footage, witness evidence, or any other means to calculate the velocity such as $D=Vt$, forensics anthropology experts will need to analyze the degree of impact of the body, the properties of the surface of the landing site, the bodies posture hence the possible orientation of body on impact, nature of injuries and cause of death, any possible obstructions on the route of the fall, strength and athletic ability of the deceased and finally any physical evidence left at the launch point. With all these factors taken into consideration, further data can culminate to get a better estimate of the height and velocity, hence getting closer to the area where the crime was committed. The scene can be reconstructed after the analysis. Further analysis of the body can also lead to conclusions on whether another individual was involved in the fall, possibly freeing a convict of guilt and confirming that the death of an Individual was due to personally inflicted circumstances or due to the malfunctioning of intended equipment.

Digital forensics

The locations of an Individual and the content they observe can be identified by IP addresses. Though IP addresses can be hard to track if someone uses a dynamic WIFI service or uses a VPN, the validity of a testimony given by an Individual can be questioned with the usage of their internet, comparing the location testified to the location of the Individual, working in a trial as evidence. The Ip address is identified by network processes, routing back to the area of usage. The network is conserved between glass-topical fiber wires which transfer light with total internal reflection (TIR). TIR is when the angle of incidence of light is greater than the critical angle. The tube helps in this process by completely reflecting the light, conserving the data passing from the start to the end.

To be able to link the fingerprints of an individual to a crime scene is one of the ways to gather evidence. Comparison of fingerprints can be made by physical means, but often machine learning algorithms are employed by scanned fingerprints stored in a database. The fingerprint is scanned with the aid of the phenomenon of frustrated total internal reflection.

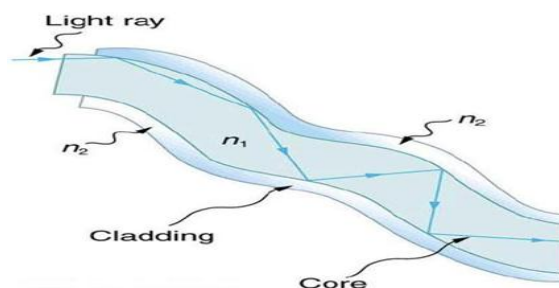

FTIR occurs when light is directed toward an interface between two mediums with different refractive indices. The light beam undergoes partial reflection and partial transmission at the interface, encountering the ridges and valleys of the finger, resulting in the scattered light rays re-entering the prism and undergoing several total internal reflections. The light is finally focused through a convex lens into an optical sensor. By analyzing the variations in the intensity or pattern formed by the reflected light, the optical sensor can form a digital representation of the fingerprint's ridge patterns, which can be saved into a database for further reference and investigation. As can be seen, specific patterns are transferred into binary and saved in a database. Similarities in the data can help single down a suspect.

An optical sensor.

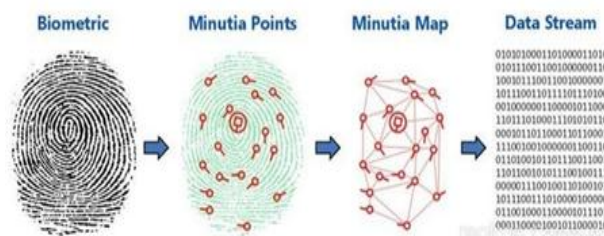
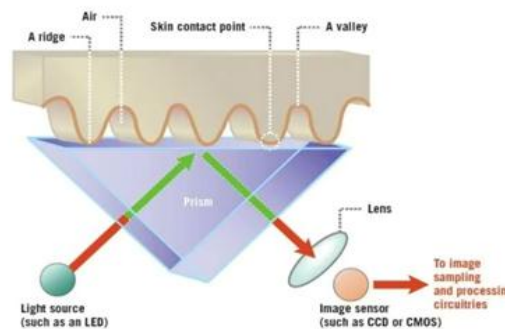

Forensics density and force

Density is a fundamental concept employed extensively in the field of forensics, serving as a valuable tool for analyzing and identifying substances and materials. By utilizing the principle of density, forensic scientists can determine the consistency of an unknown substance or compare it to known samples to aid in investigations. The density of an object is calculated by dividing its mass by its volume, allowing for the discrimination of materials with different densities. This information can be crucial in various forensic applications, such as identifying illicit drugs, analyzing trace evidence like fibers or glass fragments, or determining the composition of unknown liquids found at crime scenes. By leveraging density measurements, forensic experts can establish connections between evidentiary materials, unravel complex crime scenarios and provide crucial scientific evidence in legal proceedings.

Soil density examination in forensic investigations involves comparing the density of soil samples found at a crime scene with control samples from potential sources. Forensic scientists utilize various techniques to determine the density. One common method is the displacement method:

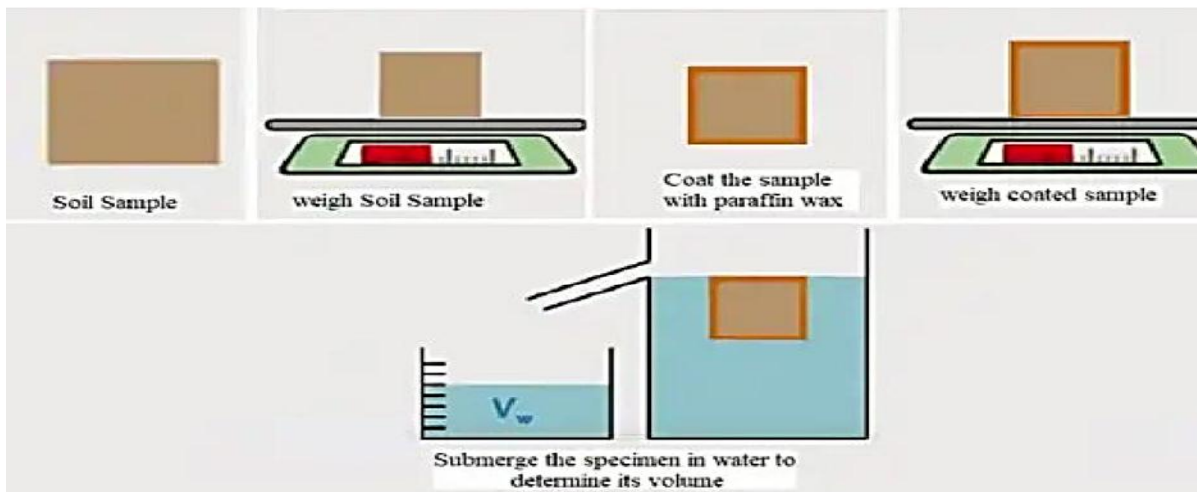

where a soil sample is immersed in a known volume of liquid, such as water or heavy liquid. The change in the volume of the liquid corresponds to the volume of the soil sample. Then by using the formula:

$$d = \frac{m}{V}$$

the soil sample by its volume, the density can be calculated.

This analysis of soil density provides valuable information in forensic investigations. Soil samples collected from a crime scene can be compared with control samples from potential sources, such as a suspect's shoes or vehicles or samples from known locations. If a match in density is found, it can suggest a connection between the crime scene and the potential source, supporting or refuting a suspect's alibi or providing evidence of their involvement. Soil density examination can also help determine the origin of soil traces found on objects or individuals, aiding in reconstructing the sequence of events or identifying potential locations associated with a crime.

The examination of glass density is another important aspect of forensic investigations. Glass fragments found at a crime scene can provide crucial evidence, such as identifying the type of glass, determining the direction of the force in a breakage, or linking glass fragments to a particular source. Density analysis of glass involves measuring the mass and volume of glass fragments. The mass is typically determined using a scale, while the volume can be calculated by techniques like water displacement similar to that of the soil density examination. It allows forensic experts to compare glass fragments found at the scene with control samples from potential sources, such as broken windows or shattered objects. If the density of the glass fragments matches the control samples, it can provide strong evidence linking the fragments to a specific source.

Glass type	Density (g/cm ³)
Silica glass	2.20
Soda lime silicate glass	2.49
Sodium borosilicate glass	2.23
Alkali silicate	3.02
Aluminosilicate glass	2.64

As can be seen in the table, glasses have specific densities, so glass fragments can be compared to create a sequence of break-ins. If any fragments seem to come out of place, this means the trajectory of a projectile could be reconstructed by analyzing the pattern of glass density variations along the fragment. This information can be crucial in providing a clear understanding of the crime and supporting or refuting witness testimonies or suspect claims.

Forensics blood stain analysis

Often the analysis of blood stains around a crime scene can help to identify the location at which the victim was first in a struggle, the angle at which they were hit and from the distance as well. When blood is subjected to external forces, such as impact or spatter, it forms unique patterns that can be analyzed to determine crucial details about the incident. The application of the principles of fluid dynamics, gravity and impact mechanics can be seen in the blood formation of different patterns based on the velocity of the impact site and the angle of hit. For example, a high-velocity hit will result in more scattered blood stains, while a low-velocity hit will be a more concentrated area of impact.

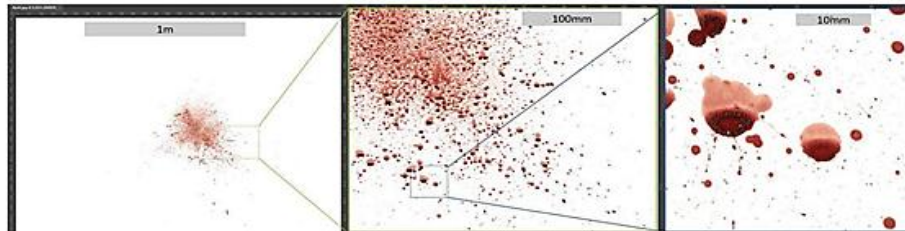

The magnitude of the blood spilled will show whether a vital spot of the body was harmed, comparing those predictions to the present body and making conclusions based on if another Individual is involved or if the victim fought back.

For example:

This stain showcases the pattern of a high-velocity and high-force hit to a body, with further analysis, it can be seen that the top-left middle of the stain contains a gap that has similar dimensions to a bullet, with these variables combined, it can be inferred that a bullet was used to kill or severely injure a victim and form this stain. In this case, the body can't be found close to the stain, so it can be concluded that the hit was performed with a firearm. With further analysis of the gap in the blood stain, the caliber of the firearm can also be identified. If the body isn't present, but there are more blood stains from various locations, then the sequence in which the body was discarded /moved can be identified, going as far as to bring the conclusions of other victims being present in the vicinity.

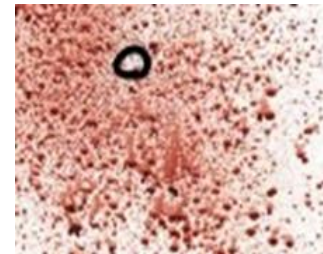

From any blood stain, the different angles of hits can be found using the elongated shapes that blood forms:

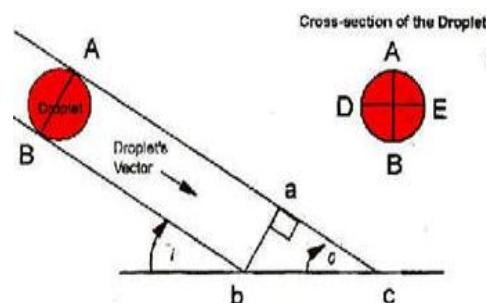
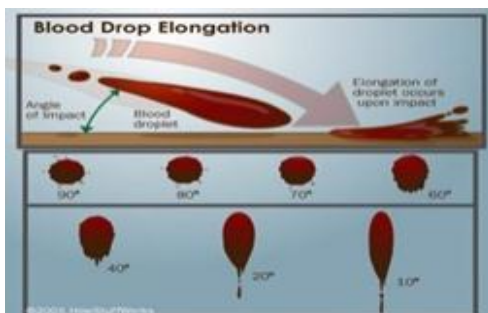

With the angle of impact identified, the vector of the droplet can be concluded, hence determining the degree of force applied on the victim to induce the according to the stain, removing or adding possibilities of murder weapons, identifying if they are blunt or sharp and if the murder weapon is within close vicinity or not.

The trend of criminal cases In India

In the year 2021, a total of 60,96,310 cognizable crimes were compiled, with 36,63,360 being Indian Penal Code crimes and 24,32,950 Special & Local Laws crimes registered. This number showed a decline of 7.6% in the registration of cases from the previous year. A total of 11,00,0425 cases were offenses against the human body, out of which a total of 5,85,774 of which resulted in hurt cases. The cause of death by negligence was 13.3% of all cases, and kidnaps & Abductions were 9.2% of all cases. In total, the cases registered under offenses against the human body increased by 5.1% in 2021 over 2020, and the overall crime rate has increased from 77.4% to 80.% in 2021. This trend shows an increased rate of physical violence, and more markers are needed in this day of society to crack cases regarding the death of Individuals. Could it have been a death influenced by self? Could it be due to the actions of another individual who had fled the scene? These questions can only be identified by the forensics division (if no eyewitness comes forward).

The types of cases discussed are the major ones but there are also marginally smaller forms of cases that have seen a great increase. Crime against women has increased by over 15.3%, crime against children has increased by 16.2%, Offences against property have increased by 18.5%, economic offenses have increased by 19.4% and finally missing persons have increased by a staggering 20.6%. Throughout these cases, the main act of Identifying the variables involved in these cases has been up to investigators and forensics scientists assigned to these cases. The collection of fingerprints from people in the close vicinity and that of the walls and surfaces, the comprehensive review of relevant evidence such as blood stains and within close vicinity, broken materials can help rebuild the scene. Non-violent cases such as the smuggling of illegal goods have been tackled with mass-spectrometry or XMRFs to identify the substance present and accordingly seizing them. Rapes and sexual assaults have been tackled with DNA-Identification, using mas- spectrometry, gas chromatography and some more acute details can be picked up by the SEM.

Conclusion

Forensic science, with its diverse branches and applications, plays a crucial role in modern society by providing accurate and reliable investigations and analyses of crime scenes. The field has evolved significantly, utilizing physics principles and techniques to enhance the accuracy and efficiency of forensic investigations. From fingerprint analysis in the early days of forensics to the advanced use of spectrometry, ballistics analysis, microscopy and bloodstain pattern analysis, physics has become an essential tool in unraveling complex cases and providing critical evidence in legal proceedings.

Forensics is split up now into countless divisions, these divisions being Ballistic forensics where formulas and equations are employed to reconstruct shooting incidents, identify possible shooter locations and analyze trajectories and impact velocities. Material analysis forensics division using techniques like X-ray fluorescence and mass spectrometry allows for the identification of elements and compounds, aiding in the identification of trace evidence and providing valuable insights into the origin and association of evidence. Physics concepts such as density are employed to determine the consistency of substances, analyze soil and glass samples and establish connections between evidentiary materials. Digital forensics utilizes physics principles to trace IP addresses and analyze fingerprints using phenomena like frustrated total internal reflection, providing valuable evidence in cybercrime investigations. In bloodstain pattern analysis, fluid dynamics, gravity and impact mechanics are employed to interpret bloodstain patterns, helping to determine the angle and velocity of impacts and reconstruct the sequence of events. The fields of forensics continue to advance alongside the increasing complexity of criminal activities and technology. Forensic scientists, equipped with physics knowledge and analytical tools, contribute to the identification of criminals, the resolution of criminal cases and the delivery of justice in society.

Referred sources

<http://www.fondelco.in/institute/forensic-physics.php>

https://www.mha.gov.in/sites/default/files/2022-09/IFS%282010%29-FinalRpt_0%5B1%5D.pdf

<https://dfsl.maharashtra.gov.in/en/physics>

<https://www.sciencedirect.com/topics/medicine-and-dentistry/bloodstain-pattern-analysis>

<https://physicsworld.com/a/the-physics-of-blood-spatter/>

https://www.researchgate.net/figure/schematic-diagram-of-FESEM96_fig13_331843605

<https://www.bruker.com/it/products-and-solutions/elemental-analyzers/xrf-spectrometers/how-does-xrf-work.html>

<https://www.bronkhorst.com/int/blog-1/mass-spectrometry-and-mass-flow-control-a-closer-look-at-ion-them/inated%20from%20living%20organisms.&text=An%20age%20could%20be%20estimated,an%20internationally%20used%20reference%20standard.>

<https://c.realm.com/in/post-details/1330901494630711296>

https://www.researchgate.net/figure/Comparison-of-the-densities-of-glass-types_tbl3_328007176

<https://ncrb.gov.in/en/Crime-in-India-2021>

PHYSICS IN FORENSIC SCIENCE

Mannit Goyal

D.A.V Public School, B.R.S Nagar, Ludhiana

What is forensic science?

Forensic Science is the application of science to criminal and civil legislation. It is controlled by the legal criteria of acceptable evidence and criminal process, particularly during criminal investigations.

What is forensic physics?

The study and comparison of diverse physical evidence based on its physical characteristics, such as density, refractive index, resistivity, temperature, luminescence, elasticity and composition, is the focus of the forensic physics.

What types of evidences are examined in forensic physics?

- Paints
- Glass
- Soil
- Tool Marks
- Ropes
- Fibers
- Threads
- Obliterated Marks
- Metallic Pieces

What kind of crimes does forensic physics apply to?

- Cases of Accidents
- Firearm and Bullet Profile Analysis
- Glass Penetration of Speedy Stone
- Fire, Arson and Explosive Investigation
- Materials Identification
- Software based imaging

Let us take an example to understand the role of physics in forensic science.

Near June 1995, a young lady was discovered at the base of a cliff near Sydney, Australia. The location was a well-known location for suicides, so the authorities thought she had committed suicide there. But in reality, the woman's boyfriend was found guilty of killing her. It took ten years to realize that the woman was tossed down the cliff, not jumped. It took so long, mostly because the police were unaware that physics could assist in solving the issue.

How physics solved the case?

The victim could not have thrown herself as far away from the cliff as she landed, according to the physicists, given the limited run-up distance that was available. She was discovered about 12 metres out from the 30-metre-high ledge. The speed at which a typical woman could sprint, jump and dive was tested in studies with volunteers from a police school. Men were used to hurl ladies into a pool to test launch velocity. A group of girls were put to the test while jogging uphill on level terrain. They discovered that she had to have been thrown after conducting research for more than a year.

Various Instruments in forensic analysis:

1. Electron Microscope

The electron microscope is a powerful tool used in various aspects of forensic science due to its high magnification and resolution capabilities. It enables forensic experts to examine minute details of

evidence, which can be crucial in criminal investigations. Here are some applications of electron microscopes in forensic science:

- Forensic Trace Evidence Analysis
- Tool mark Analysis
- Forensic Fingerprint Analysis
- Document Examination
- Gun and Bullet Analysis
- Drug Analysis
- Biological Evidence Examination
- Firearm Serial Number Restoration

2. Mass Spectrometer

The mass spectrometer is a powerful analytical instrument used in various applications within forensic science. It helps identify and quantify the composition of different substances based on their molecular masses and fragmentation patterns. Here are some significant uses of mass spectrometry in forensic science:

- Drug Analysis
- Explosives Analysis
- Forensic Toxicology
- Arson Investigation
- Ballistics and Gunshot Residue Analysis
- Ink Analysis
- Environmental Forensics
- Isotope Analysis
- DNA Sequencing
- Post-mortem Analysis

3. Photoluminescence Phenomenon

Photoluminescence is a phenomenon where a substance absorbs photons (light energy) and re-emits photons at a longer wavelength, producing visible light. In forensic science, photoluminescence plays a role in various applications that aid in evidence detection and analysis. Here are some uses of photoluminescence in forensic science:

- Bloodstain Detection
- Latent Fingerprint Detection
- Fiber and Trace Evidence Analysis
- Document Examination
- Drug and Chemical Detection
- Arson Investigation
- Impression Evidence Analysis
- Counterfeit Currency Detection

Ultraviolet Light

Ultraviolet (UV) light is extensively used in various applications within forensic science due to its ability to reveal, enhance and analyze evidence that may not be visible under normal lighting conditions. Here are some significant uses of ultraviolet light in forensic science:

- Bloodstain Detection

- Latent Fingerprint Detection
- Body Fluid Analysis
- Document Examination
- Counterfeit Currency Detection
- Hair and Fiber Analysis
- Gunshot Residue (GSR) Analysis
- Post-mortem Analysis
- Paint and Varnish Analysis
- Arson Investigation

5. X-Rays

X-rays play a significant role in forensic science, particularly in examining and analysing evidence related to various criminal investigations. X-ray imaging provides valuable information about the internal structure of objects without the need for destructive testing. Here are some applications of X-rays in forensic science:

- Forensic Pathology
- Firearms Examination
- Document Examination
- Forensic Anthropology
- Identification of Foreign Objects
- Forensic Entomology
- Tool mark Analysis
- Drug Smuggling Investigations
- Archaeological Forensics

Let us take one hypothetical example

Case Study: Blood Spatter Analysis in Forensic Science

A body is discovered in a domestic living room during a homicide investigation with numerous bloodstains on the walls, floor and furniture. Although the absence of a clear murder weapon and contradicting witness accounts leave the authorities confused as to what precisely happened, they first believe that a domestic altercation gone wrong. The forensic team is brought in to examine the bloodstain patterns and offer explanations for the chronology of what happened.

How physics will solve the case?

1. **Surface Tension:** The first step in the study is to look at the size and form of individual blood droplets. Experts in forensics can estimate the angle of impact between the blood source (such as the victim) and the surface where the stain was deposited by looking at how the morphology of the droplets is affected by the surface tension of the blood.
2. **Velocity and Energy:** Based on their size and distance travelled, blood droplets' velocities and energies are calculated using physical principles. Low-velocity impact spatters are more likely to be the result of blunt force, but high-velocity impact spatters may be the result of a gunshot or stabbing.

3. **Terminal Velocity:** Based on the size and density of blood droplets, forensic experts can determine their final velocity. This information, such as whether the sufferer was standing, sitting, or lying down when hurt, aids in determining the height from where the blood came.
4. **Stain shape and Spatter Patterns:** The forensic team can ascertain the direction and order of the impacts by examining the form and distribution of the bloodstains. For instance, extended stains may reveal movement or travel during the incident.
5. **Area of Convergence and Origin:** Trigonometry and geometric analysis are used by the blood spatter analyzers to pinpoint the area of convergence—the location in space where the blood droplets originated. This can assist in determining where the victim and the attacker were when the incident occurred.

Let us analyze the areas where forensic science can be used

➤ Road Accidents

Forensic science for auto accident investigations depends heavily on physics. To assess vehicle speeds and study collision dynamics, experts employ the laws of motion, momentum and energy. The order of events and the forces involved can be inferred from tyre marks and vehicle deformations. Crash reconstruction is aided by mathematical models and computer simulations. Additionally, physics assesses the efficacy of airbags and seatbelts, impact analysis and rollover probability. By using this scientific method, forensic specialists offer crucial testimony for court cases and insurance disputes, adding to our understanding of road accidents and advancing our efforts to make roads safer.

➤ Fire and Burns

Forensic science studies into fire and burns rely heavily on physics. Experts use the concepts of heat transmission, thermodynamics and combustion to comprehend the behavior of fires, the causes of their ignition and how flames spread. They identify the fire's source and probable causes using temperature data and fire patterns. Calculations based on physics evaluate burn depths, thermal damage and the level of heat produced by a fire. The detection of concealed fire sources is aided by thermal imaging and infrared technologies. To better understand fire accidents, forensic professionals who specialize in physics utilize their knowledge to help pinpoint the origin, cause and effects of flames and burn injuries.

➤ Drowning in water

Forensic science for water drowning cases depends heavily on physics. To comprehend drowning accidents, experts use buoyancy, hydrodynamics and fluid mechanics concepts. They evaluate the body's location in the water, water currents and movement patterns using these concepts. Calculations are used to pinpoint the site of the drowning and the length of time the corpse was submerged. Forensic scientists can distinguish drowning from other causes of death by examining the distribution of water in the lungs and stomach. Physics-based models help to simulate the drowning scenario and offer important information for figuring out the specifics and causes of water-related fatalities.

➤ Falling from height

Forensic science for cases of falling from height investigations heavily relies on physics. Experts use impact analysis, motion theory and the laws of gravity to comprehend the mechanics of falls. To establish the height of the fall, they compute the velocity and energy upon impact. Reconstructing the timeline of events is made easier by studying the trajectory and falling angles. Physics-based simulations assist in reenacting the fall's conditions and offer crucial information for figuring out if the fall was unintentional, suicidal, or the result of foul conduct. To gain a thorough knowledge of falling accidents and their causes, forensic professionals employ physics.

➤ **Sudden Explosion/ Blast**

When examining abrupt explosions or blasts, forensic science heavily relies on physics. To comprehend the properties of the explosion and the propagation of the blast wave, thermodynamic and fluid dynamics principles are employed. To pinpoint the explosion's origin and possible causes, forensic specialists compute the explosion's pressure, velocity and energy. Analyzing debris patterns can help determine the kind of explosive device that was utilized. Modelling of shockwave propagation aids in simulating the explosive situation. Comprehensive investigations of explosion-related accidents benefit from the use of physics-based evidence since it aids in the identification of suspects, the reconstruction of events and the assessment of the effects of the explosion on both structures and people.

➤ **Injuries due to shooting/fighting-**

Physics is essential in forensic science for investigating injuries resulting from shootings or fights. Ballistics principles are applied to analyze bullet trajectories and identify the type of firearm used. Energy transfer calculations help determine the severity of injuries caused by bullets or other projectiles. Forensic experts examine patterns of wounds and bruising to reconstruct the sequence of events during a fight. Impact force analysis aids in understanding the potential damage inflicted by weapons or blunt objects. By applying physics, forensic specialists provide valuable evidence in identifying weapons, understanding the dynamics of the incidents and assisting in legal proceedings related to shooting and fighting injuries.

Let us go into details of some topics

➤ **Fire Investigation**

Physics plays a critical role in fire investigation, involving the analysis of fire cause, origin and behavior. Understanding heat transfer, thermodynamics and combustion is vital for studying fire patterns, identifying ignition sources and reconstructing fire events. Physics helps examine fire effects on materials, analyse burn patterns and determine factors like fire spread, temperature and flashover. This data assists in distinguishing accidental fires from deliberate ones, providing crucial evidence in arson investigations.

In fire investigations, physics is also used to analyse accelerants, like gasoline or residues. Techniques such as gas chromatography and mass spectrometry utilize physics principles to identify chemical compounds in fire debris samples. Analyzing accelerant behavior and distribution helps determine if flammable substances were intentionally used to start or fuel the fire.

Fire modelling, another physics-based application, involves simulating fire dynamics, smoke movement and heat transfer within a structure. These models reconstruct fire progression, assess the impact of ventilation and fuel sources and provide insights into complex fire behavior.

By applying physics in fire investigations, forensic scientists can ascertain fire cause and origin, study fire behaviour patterns and offer valuable evidence for legal investigations and insurance claims related to fire incidents.

➤ **Forensic Ballistics and Gunshot Residue Analysis**

The examination of firearms and the analysis of gunshot residue (GSR) make use of principles from physics. Forensic ballistics is the study of bullets, firearms and ammunition, involving the analysis of projectile properties, bullet trajectories and the influence of factors like wind resistance and gravity on bullet paths.

Gunshot residue analysis involves inspecting particles left on people or objects near a fired gun. Physics-based techniques, such as scanning electron microscopy (SEM) and energy-dispersive X-ray spectroscopy (EDX), are utilized to identify and study gunshot residues. This analysis relies on understanding the physics behind their formation, distribution and transfer when a firearm is discharged. The findings can help determine if a firearm was present at a crime scene, the distance between the shooter and the target, and potentially link a suspect to a specific weapon.

By applying physics principles in forensic ballistics and gunshot residue analysis, investigators can present crucial evidence regarding the use of firearms in crimes, identify the type of weapon used and establish connections between individuals, weapons and crime scenes.

➤ **Forensic Firearm and Tool mark Analysis**

Physics principles play a crucial role in the examination of firearm-related evidence, encompassing bullets, cartridge cases and tool marks found on surfaces. Forensic experts apply concepts from ballistics, materials science and optics to analyse firearms, ammunition and the distinct markings they create. Through techniques like comparison microscopy they can match a fired bullet or cartridge case to a particular firearm by studying microscopic patterns left by the gun's barrel and breech face. Moreover, physics-based methods are utilized to study the effects of ricochets, deflections and other phenomena that may occur during shootings or tool mark impressions. This aids in reconstructing events and establishing connections between weapons and crime scenes.

The application of physics in forensic firearm and tool mark analysis is essential for accurately interpreting physical evidence and providing vital information in criminal investigations. This includes linking firearms to crimes, identifying potential suspects or weapons used and evaluating the reliability of witness testimonies.

➤ **Vehicle Accident Reconstruction**

Physics principles are applied in the reconstruction of vehicle accidents to ascertain essential details like vehicle speed, point of impact and the sequence of events leading to the collision. Forensic experts analyse factors such as skid marks, deformations and damage patterns, using concepts of motion, momentum and energy to calculate velocities, forces and angles involved in the accident. This data is crucial for establishing liability, understanding collision dynamics and providing crucial evidence in legal proceedings.

Accident reconstruction entails examining elements like friction coefficients, conservation of linear and angular momentum, energy transfer and vehicle or object deformations. By combining these physics principles with empirical data and computer simulations, forensic investigators can create accurate reconstructions of vehicle accidents, aiding in determining the cause and contributing factors.

Accurate accident reconstructions offer valuable insights into the events leading to a collision, facilitating fault determination, injury assessment and the implementation of safety measures to prevent similar accidents in the future.

➤ **Forensic Fluid Dynamics**

Forensic science utilizes fluid dynamics, a branch of physics, to analyse the behavior and motion of fluids like blood, water and bodily fluids at crime scenes. This understanding helps investigators determine the origin, path and dispersion patterns of fluids involved in criminal activities.

For instance, when examining blood spatter, physics principles such as blood viscosity, surface tension and interaction with different surfaces are taken into account. By studying the size, shape,

distribution, directionality and impact angles of bloodstains, forensic scientists can reconstruct the events leading to the bloodshed. Fluid dynamics is also valuable in distinguishing between high-velocity impact spatter (e.g., from gunshots) and low-velocity spatter (e.g., from blunt force injuries).

Moreover, fluid dynamics plays a role in underwater crime scenes, such as drownings or evidence disposal in bodies of water. Understanding water currents, buoyancy and the behaviour of submerged objects is crucial for locating and retrieving evidence underwater.

Through the application of fluid dynamics principles, forensic scientists can extract crucial information from fluid patterns, assisting in event reconstruction and providing vital evidence in criminal investigations.

CRIMINAL RATES IN LUDHIANA

Crime rates in Ludhiana, India

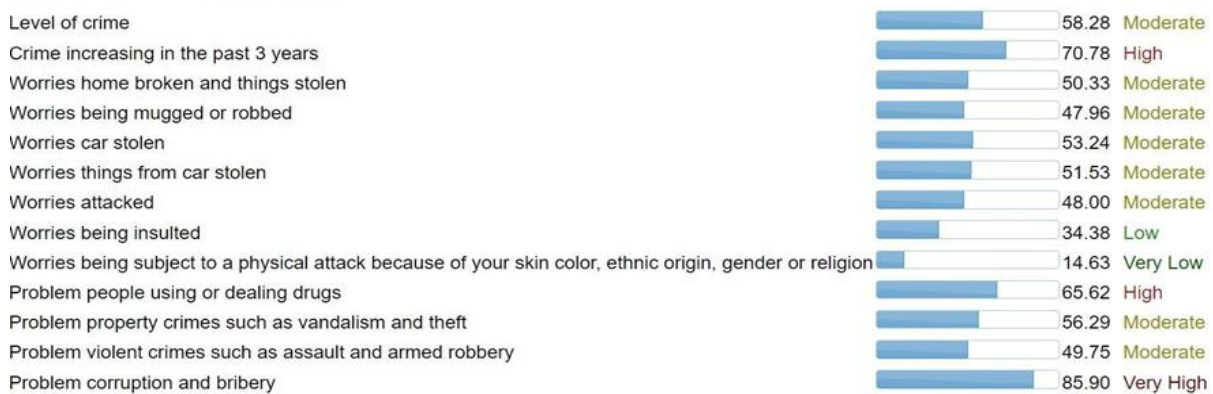

Source: <https://www.numbeo.com/crime/in/Ludhiana>

Conclusion

In summary, this research paper delves into the intriguing convergence of physics and forensic science, underscoring the vital role physics plays in contemporary forensic investigations. By applying principles such as mechanics, optics, thermodynamics and electromagnetic theory, forensic experts can effectively decipher intricate crime scenes, analyse evidence and provide invaluable contributions to the legal system.

The examination of bloodstain patterns, bullet trajectories and ballistics illustrates how physics concepts are indispensable in reconstructing crime scenarios and comprehending the dynamics of violent incidents. The utilization of advanced forensic imaging techniques, like X-rays, MRI and CT scans, demonstrates how physics advancements have augmented our capacity to visualize internal structures and detect concealed evidence.

Moreover, the scrutiny of diverse physical evidence, such as fibres, glass and metals, underscores the significance of material science in forensic investigations. These analyses facilitate connecting suspects to crime scenes and establishing crucial links between evidence and potential wrongdoers.

Physics has also made substantial contributions to forensic toxicology, where the study of drug metabolism and trace analysis assists in identifying substances within the human body and linking them to criminal activities or suspicious deaths. While physics furnishes invaluable tools for forensic scientists, it is essential to acknowledge the limitations and challenges in its application. Issues related

to interpretation errors, calibration inaccuracies and the impact of environmental factors necessitates continuous improvement and meticulous consideration.

In conclusion, the integration of physics principles into forensic science has brought about a paradigm shift in the way we approach and comprehend criminal activities. As technology advances and our comprehension of physics deepens, forensic science will continue to evolve, ensuring a more accurate and expeditious delivery of justice. Collaborative efforts among physicists, forensic scientists, and law enforcement will remain critical in harnessing the full potential of physics in forensic investigations, ultimately creating a safer world for all.

PHYSICS IN FORENSIC SCIENCE

D. Usharani

Department of Physics, MES College of Arts, Commerce and Science, Malleswaram, Bangalore

The term forensic is derived from the Latin word *Forensis* which means the ‘forum’ and has the synonyms such as scene, environment. Forensic Science is known by another name as criminalistics and deals with the application of scientific knowledge to unearth evidences in the quest of truth in criminal investigations. Collection of forensic evidence is shown in movies as broken glass pieces for finger prints, blood – stained clothes, weapons such as knife, pistol etc., hair strand, shirt buttons, cigarette butts, burnt items and others which is the most exciting part of a crime investigation. These are then sent to a forensic lab for reports, corroborated with analysis, based on which conclusions can be drawn on the suspects leading to perpetrator/s of crime. As kids, the thrill of watching such mystery stories being solved by the best of the investigative minds as portrayed by actors and actresses was priceless. Nonetheless, the reports of forensic investigations also are handy tools in civil cases and regulatory issues. The main aim of the intensive searches, applying appropriate techniques, use of instrumentation, examining and interpreting physical evidences and knitting all of these into the mystery – solved tag requires special expertise at all levels, both human and non – human under the law of the nation.

Hence over the years, the investigative mechanisms and forensics have permeated into many subareas in physical sciences and engineering disciplines including mechanical, electrical, instrumentation and chemical engineering, in chemistry (mainly drug and toxicology), biology (serology and DNA profiling) and fire science. With the rapid advancement in ICT, the need for expertise in investigating cybercrimes has increased manifold.

As a physics teacher, I would, in the following paragraphs, describe physics in forensic science which is an interesting area to explore and one of the many domains where it needs transfer of book–knowledge to real – life situations.

Amongst the seven principles in forensic science, the principle of exchange relies upon this natural phenomenon enunciated by the French Scientist - Edmond Locard. It states that “Whenever two entities come in contact with each other, they exchange the traces between them.” In the context of the above principle, all fundamental laws of physics can be applied while recreating a crime scene, analysing the reason for road accident, investigating an explosion, identifying fake jewellery and so on and therefore physics in forensic science is a domain that is intriguing, nothing less than the thrill of watching an action-packed James Bond movie or a Bollywood movie – CID, *Andhadhun* alike.

Physics as a subject involves many laws, concepts, mathematical equations and solving problems and scope of the contribution of fundamental physics in forensic science has been immense and crucial. The branch makes use of the fundamentals in mechanics/kinetics such as mass, force, time, velocity, projectile motion and collisions to investigate road accidents, firing of a bullet into a human being, sound waves for voice detection, marks around the neck in suicide cases, strangulation marks around the neck in case of crime etc.

A thorough application of the physics concepts and some numerical calculations would eventually help in the investigation of crimes. The investigations are incomplete and inconclusive without the aid

of sophisticated instruments like optical microscope, the electron microscope, the mass spectrometer, and optical spectrometers (optical physics) are used in the forensic labs but has not been published extensively. While I understand that the most widely used instrument is a microscope, the other instruments are specific to the application and the nature of investigation. In the last three decades, the use of the photoluminescence, EDX, XRF, SEM and XRD phenomenon for physical evidence examination, material characterization, with latent fingerprint detection have made significant inroads in forensic science to augment the physics book–knowledge with the practical application aspects. Knowledge of instrumentation by itself could be another branch of forensic science.

As the title of the essay reads Physics in forensic science, I would like to describe a few facets of physics in forensic science elaborately in the following paragraphs with illustrations for a better understanding.

I MECHANICS / KINEMATICS

The fundamentals in mechanics/ kinematics are integrated based on the mass, force, time, velocity, momentum.

For instance, in the first picture, the application of concepts in projectile motion will throw light on the speed at which the driver was driving at the time of falling off the flyover as the range can be calculated approximately. Also, the state of the vehicle after the fall will reveal the nature of the accident whether it was on a plain ground or from a height, in case, if there are no witnesses to the accident which could have happened at night.

In the other two pictures just below, (a head–on collision investigation or collision in the same direction), the extent of damage to each of the vehicles would reveal the speed at which the vehicles were moving and this kind of a study is not isolated from the application of material science: the stress, the strain of the materials and how much of the speed it could be for the materials to take such an impact. This study is very laborious as it involves different parts made up of different materials and data of all such commonly used materials should be available in the forensic laboratories.

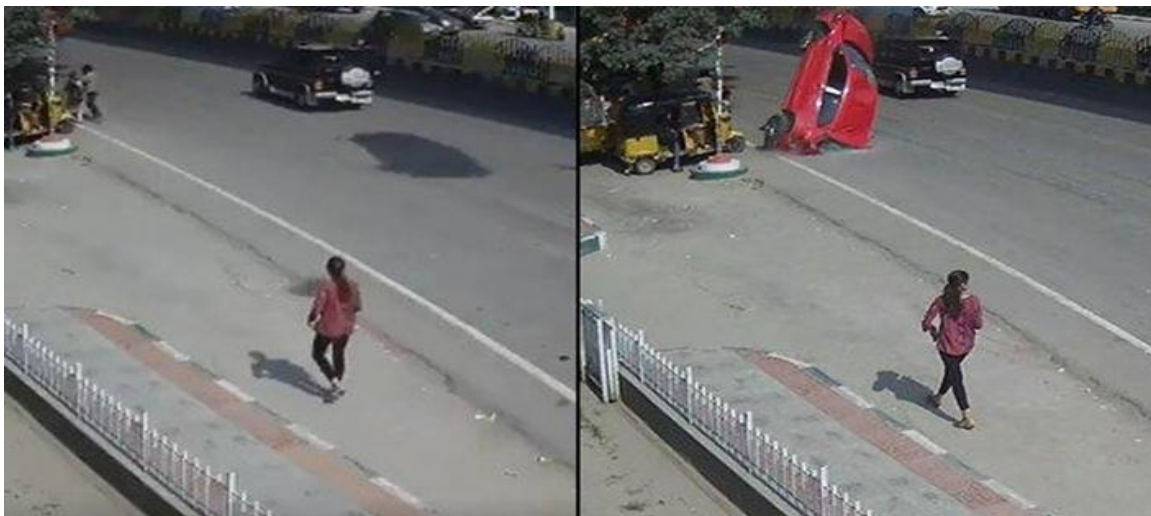

A horrifying accident: a speeding car that fell off a flyover



Accidents which involve a head-on collision and collision in same direction

The elements of trajectory related to firing of a bullet from a gun either as a parabolic trajectory or a straight-line trajectory are equally interesting as we apply the concepts in kinematics.

Elements of a trajectory

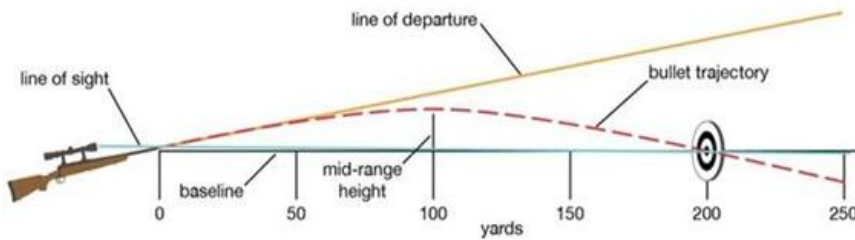

Parabolic path of a bullet



Straight line path of a bullet

The mathematical equations related to the ballistic missiles are **ballistic and bullet drop**:

Ballistic drop represents the ability of the bullet to overcome air resistance and defines its efficiency in flight.

$$C = \frac{W}{id^2}$$

where W is the weight of the bullet. I is the form factor and d is the diameter of the bullet.

$$\text{Bullet drop } B = 4 \times \text{mid range height}$$

The extent of injuries is analyzed by the shock waves and cavitation effect. The diagram below gives us an understanding of the generation of shock waves due to the impact of the missile and its entry and exit points.

Shock Waves & Cavitation Effect

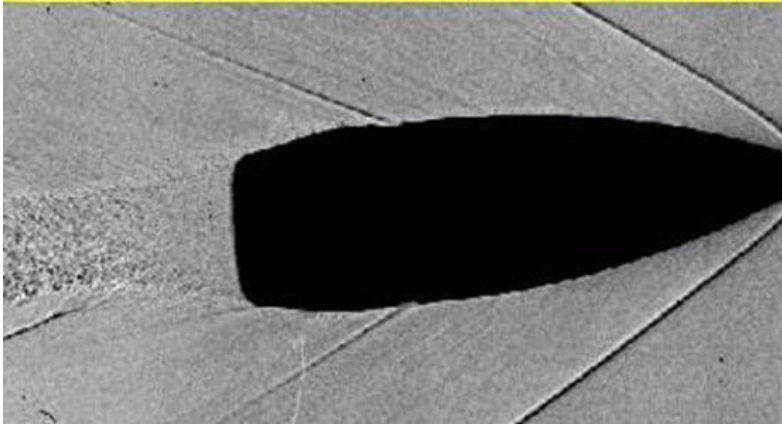

The incident that passed in my thoughts as I write this paragraph is the gruesome killing of Gauri Lankesh, 55, an outspoken critic of right-wing Hindutva. She was shot dead outside her home in west Bengaluru on the night of September 5, 2017 by two motorcycle-borne assassins. Three of the bullets pierced Gauri's head, and chest, resulting in her death at her doorstep.

The depth of penetration of the bullet depends on the body mass, angle of entry with respect to the horizontal, the power of gun that would be used and distance between the weapon and target. All these would be intertwined with the position of the victim after the firing which lead to conclusions about a person X committing the crime. It was later learnt that the victim was shot dead from close range when she was standing near the gate of her house.



Gauri Lankesh and forensic evidence

II. VISUAL SPECTRAL COMPARISON

Cases of altered documents, detection of fake currency notes, forged cheques and identification of precious stones from the spurious ones, employ infrared reflectance and infrared luminescence under the broad heading Visual Spectral Comparison (VSC). The main features of VSC are:

- Hi-Fi imaging technology
- High resolution
- Full range light sources
- Latent images
- Intelligent software
- Image processing and enhancement
- Hyper spectral imaging

A few interesting illustrations and the related aspect are shown below:

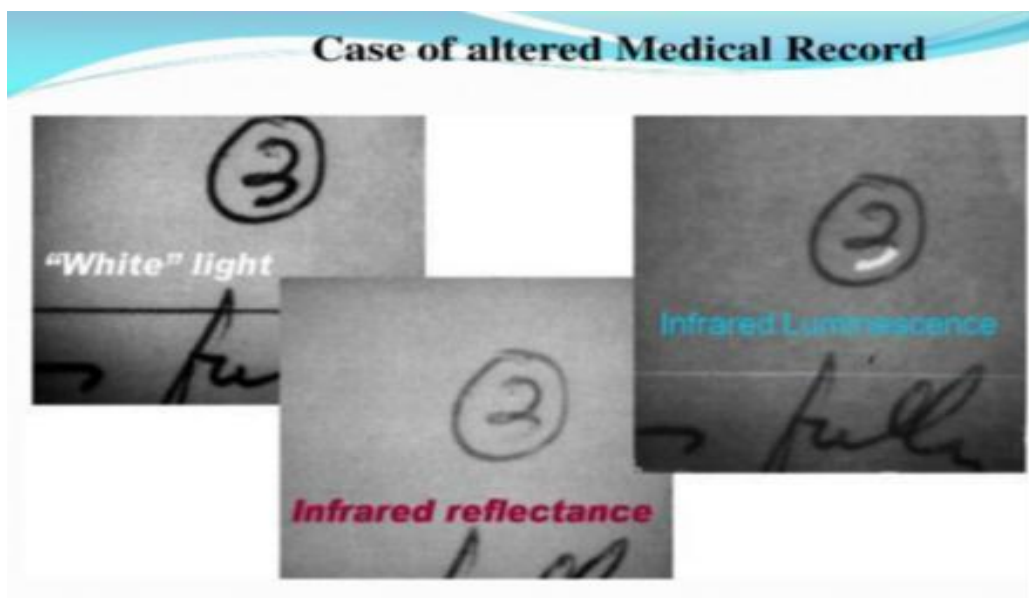

An altered document in which number 2 is altered to number 3



A fake currency detected by VSC

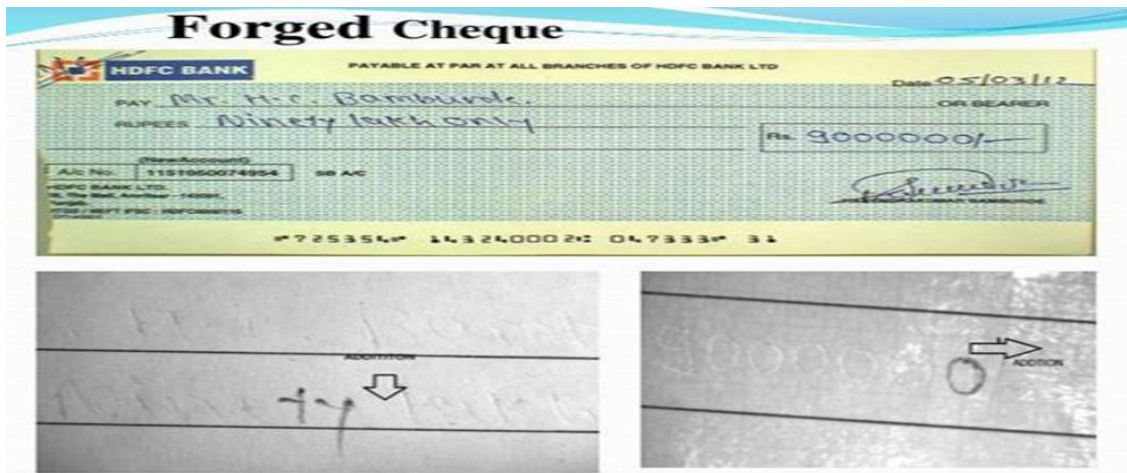

A forged cheque where nine is changed to ninety and a zero is added

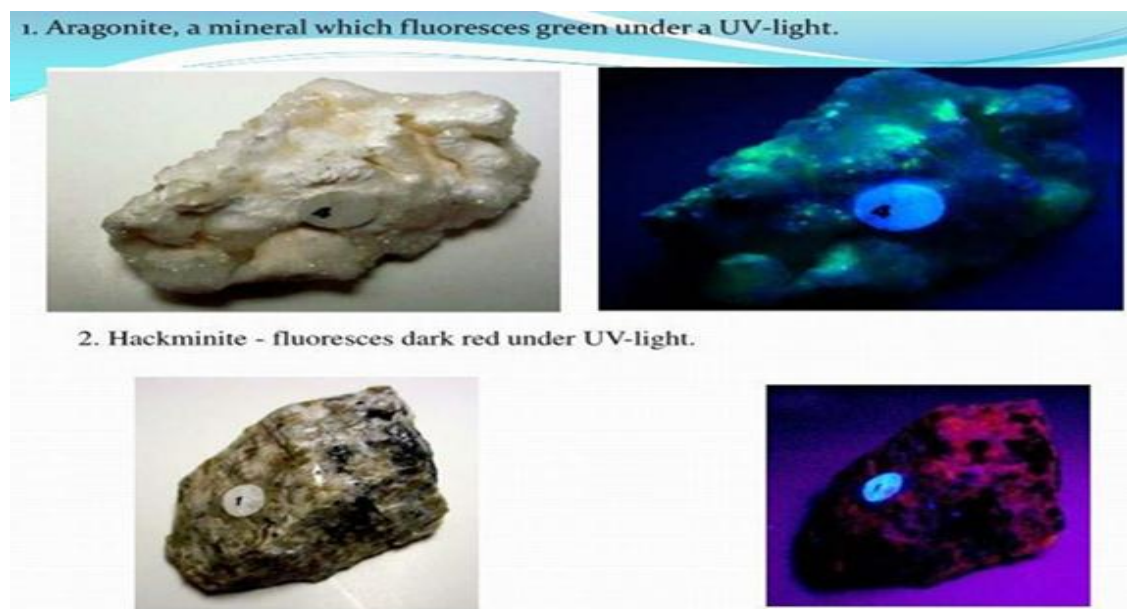

Identifying the genuineness of minerals

III. BLOOD SPLATTER

A crime committed using a knife, broken glass or a hard object often requires the recreation of the scene which invariably involves blood splatter. Blood being a fluid, we need to look into the fluid dynamics (equation of continuity) associated with it. Blood drops are spherical in shape due to surface tension. When a crime scene needs to be investigated, the aspects that become a handy tool in physics is the application of concept of gravity, viscosity and the surface tension to the blood drops. A few related points are as follows:

1. Origin of the stain pattern
2. Number of blows with the weapon
3. The diameter of the blood stains increases as the height increases.
4. The angle of impact is calculated by knowing the length and width of the splatter.

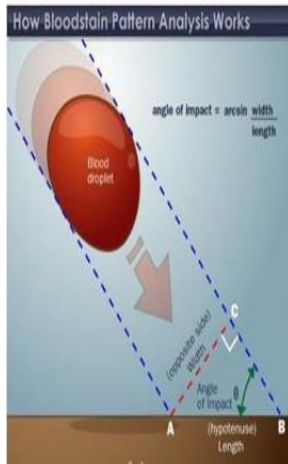

$\sin a = w/l$

Therefore,

$a = \arcsin(w/l)$

Where, l= length of spatter

w= width of spatter

a= angle of impact



Passive Blood Stains

Droplets	Pools	Trails
Circular drops that vary depending on surface. Smooth = rounds drops Rough = satellites & spikes	Victim remains in one place while bleeding heavily	Spots left by the victim as they move from one place to another



IV. REFRACTIVE INDEX COMPARISON TECHNIQUE

Broken glasses are also a common sight at the crime scenes. The tiny glass pieces are collected as forensic evidences and their refractive indices are determined by a technique called SUBMERSION technique where the small piece of glass is submerged in a liquid (oil, glycerine, baby oil or water) to determine its refractive index. The pictures below illustrate the above-mentioned technique/ method.



Forensic glass analysis comparing refractive indices using submersion method



1. *Three different kinds of glass in water seen distinctly.*
2. *Borosilicate glass disappears in glycerine while the flint glass is seen.*
3. *The borosilicate and flint glass have almost disappeared in oil.*

The pieces of glass collected as forensic evidence are immersed in different liquids in a lab. The glass that disappears in a particular liquid without being seen (as in case 2 in the above illustration) has the same refractive index as that of the liquid. This method is employed in identifying the source of the broken glass pieces in forensic investigation.

V. VOICE COMPARISON

Forensic voice comparison (i.e., forensic speaker recognition, identification, and voice comparison) is a sub discipline of forensic science in determining the authenticity of questioned voices by comparing the analytical results and drawing inferences from the comparison of reference and suspect voice recording. Voice identification could be applied as discourse recognition i.e., identification of speech or phonetics of signals, and speaker recognition i.e., to identify a speaker.

Acoustic voice analysis based on disturbances, and measures have been the objective for examining voice quality. The voice profiling from speakers is collected as specimens and this speaker profiling aids the investigating labs to identify the true criminal and to narrow down the investigation. However, in the absence of such samples, it becomes difficult to prove the involvement of that individual in any criminal activity as speaker identification is not feasible.

The numbers: Last year

Division	Murder	Attempt to murder	Dacoity	Robbery	Chain-snatching
Central	15 (14 detected)	34(32)	2(1)	54(29)	13(10)
West	47(45)	163(136)	14(13)	193(160)	80(75)
North	36(33)	138(138)	11(10)	131(111)	54(41)
South	29(29)	57(52)	9(6)	98(80)	69(66)
East	23(22)	57(38)	NILL	28(14)	14(9)
Northeast	17(16)	32(19)	4-2)5	5(19)	20(18)
Southeast	25(25)	48(38)	4(4)	64(37)	33(29)
Whitefield	19(19)	40(35)	2(2)	39(32)	14(6)

Source: Bengaluru police | Solved cases in brackets



S. No.	Crime Head under IPC	Total Cases for Investigation	Charge-sheeting Rate	Total Cases for Trial	Total Cases Convicted	Conviction Rate
1.	Murder	3,289	90.7	19,415	364	41.3
2.	Rape	4,566	87.7	18,425	279	22.4
3.	Rioting	4,214	92.4	27,457	358	29.4
4.	Kidnapping & Abduction	30,438	20.5	23,973	283	23.3

CONCLUSION

Physics in forensic science is notably a significant branch of the mentioned science and there are myriad applications in the domain to investigate crimes and eventually identify the perpetrators of crime. Use of instrumentation, electronics and computer technology are on a high pedestal, so much so, that they are an integral part of the branch. However, physics in forensic science has not been publicized to the desired level as a potential domain of employment. The interest in this science for the undergraduate students can be created by introducing this in applied physics paper or as an open elective to students who have taken physics as a core subject. Visits to the forensic labs could arouse interest and would be a bridge between class room teaching and exposure to the application of the knowledge.

References

1. Power point presentation by Physics in Forensic Investigations by N.M. Fatangare, Govt. Institute of Forensic Science, Ahmedabad (for illustrations).
2. Google search (for illustrations).
3. Voice identification and speech recognition: an arena of voice acoustics Sarita Sheoran¹, Dr. Dolly Mahna², Eur. Chem. Bull. 2023, 12 (Special Issue 5), 50 – 60

PHYSICS IN FORENSIC SCIENCE

Mahendra M Khandpekar

Department of Physics, B K Birla College, Kalyan, Maharashtra

Key words: Forensic Physics, Ballistics, Acoustics, Spectroscopic Techniques.

Crimes have been growing steadily all over the world and have been affecting almost every part of our life. In daily newspapers we come across heinous crimes being committed in more and more varied ways. In Western countries we can see record number of crimes being committed at much faster rate over the years. The crime investigation departments are always under pressure and in fact lag behind in investigating all these cases. Moreover we are unable to properly record all crimes because of less precise methods which are used to primarily identify and record offences. Physics has been important tool for identification, detection and prevention of crime in an unbiased manner. Physics is also used to record, analyze and digitally store more precise information about the crimes committed. In fact the basic principles, methods used and technologies developed using laws of physics form a powerful tool for the unrevealing the truth behind the crime. In fact one can see Physics in all real life applications.

There are several instances where the knowledge of Physics in such crime cases provides altogether more in- depth information to come at a conclusion. With limited or no understanding of laws of Physics, one can arrive at wrong judgments. The famous case of model Carolyn Byrne's 1995 death from cliff in Sydney, Australia which was initially claimed as suicide but physicist intervention and associated measurements and calculations helped pointed out that in fact she was murdered by her boyfriend. The case took ten years as police were unaware that Physics could help solve it. In fact, physicist Cross observed that with such short span of run-up possible of that cliff, the body could not propel far from the cliff under natural circumstances. The cliff was almost 30 meters high, and the body was found 12m out. With the help of police academy Cross performed experiments in which he actually measured how fast an average woman could run, jump, or dive. Over many years Cross tried about twenty experiments to measure launch speeds by having men actually throw women into a swimming pool, on flat or uphill surface until he came to the conclusion that the body was thrown by her boyfriend.



Slide: This cliff in Sydney where model Carolyn Byrne's was thrown off (1995, Australia)

According to Physicist Bohan, the physics applied to forensics appears to be straightforward with use of Newton's laws of motion, Collisions, thermodynamics, friction etc. of course with some subtlety.

In fact using these basics one can try to study auto accidents on roads, gun crimes with associated bullet trajectories and firing mechanisms.

Including sophisticated instrument based analysis developed on principles of Physics together with tradition methods of forensics already in use makes data more reliable and authentic. Advances in field of fundamental and applied spectroscopy are helping to detect physical properties of fingerprints on fabrics, fingerprint smears. Principle of Interference of light is used in holography to study depression in fabrics. Metal objects used during the crime and then discarded can be detected with help of archeological techniques. Optical reflectance technique helps in surface analysis to the minutest detail. Very small quantity of particles which may have significance in forensics can be detected by sophisticated neutron activation and proton micro-beam X-ray techniques. Advancement in the digital technology helps the law makers in maintaining and searching proper record of crimes, in criminal intelligence and finally in resource deployment.

I had opportunity to visit Georgia Bureau of Investigation (GBI) while I was on my exchange Visit to USA in 2017. As soon as we entered there was very typical smell of blood and of some decaying bodies. A body of person (unrecognizable) who had suffered an accident was being identified with help of some people behind a transparent Glass Screen. It was state of art forensic lab for evidence gathering, drug analysis, gun shooting deaths, glass breaking investigations, surface analysis using various sophisticated instruments like SEM, EDAX, Luminescence, FTIR, NMR, including about ten GC-MS machines working 24/7, Chemical testing, medical testing and many other laboratories for crime related events. The staff explained everything in great detail for nearly more than three hours. It was real learning experience and I started wondering how challenging and difficult it is to work in that atmosphere.



Slide: Sophisticated Instruments Lab, Georgia Bureau of Investigation (GBI), USA with Scientist explaining the Know-How.

There are invariably many examples where physics is used to investigate and solve crime. These include Ballistics, Blood Spatter, Skid Marks due to Friction, magnitude and direction of explosion and damage, shock waves, glass evidence, microscopic and forensic evidence, creating tool mark data base, reconstruction of event, soil analysis, facial reconstruction and use of sophisticated spectroscopic methods for documental evidence.

Every aspect of Forensic Ballistics includes use of Physics namely internal ballistics, external ballistics and terminal ballistics invariably using Physics for building working theories. It is interesting in almost all cases of gun firing to know where the bullet came from. The trajectory it took under the influence of Gravity. Moreover it involves the propulsion power of gun powder, the

aerodynamics and the friction in air. Every gun has its own make resulting in typical width of lands and grooves, the angel and type of twist. The rate of twist namely spin for example for bullets with specific gravity of 10.9, the Rifling Twist Rate is governed by relation $150 \times [\text{Diameter of bullet} \times 2 / \text{Length of bullet}]$. Firing of bullet (velocity- v , mass- m) in forward direction creates equal and opposite reaction- recoil in gun (velocity- V , mass- M) from which recoil velocity of gun is calculated by formula $V = mv/M$. This in turn gives an idea of force with which the target was hit.

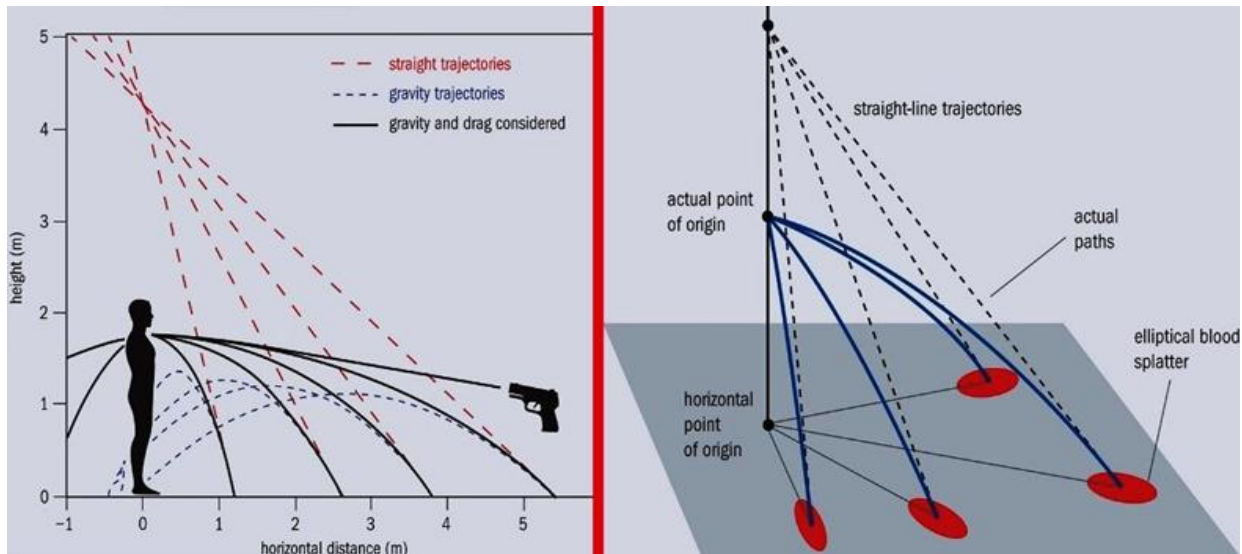

Slide: Ballistic and blood spatter Trajectories (<https://www.fondelco.in/institute/forensic-physics.php>)

Any crime created will have involvement of our body parts namely blood, bones and soft tissue. Physics is involved in every aspect of blood spatter say from the drop angle to the exact position of the victim. A careful examination and a bit of experience can make a blood spatter a good piece of evidence. Using bloodstain pattern analysis (BPA), Forensic experts form opinions to what might have happened at the crime. BPA invariably uses principles of physics namely cohesion, capillary action and velocity along with other related principles of biology and mathematics.

Typically Passive stains contain blood flows patterns forming pools under the influence of gravity acting on an injured body. When blood comes out of our body due to impact, droplets get dispersed through air and strike the surface and the stain takes the shape depending on the angle of impact, the velocity, and the distance travelled and also the type of surface. The impact energy of the weapon that causes the spatter differs resulting in various types of blood stain pattern in individual cases. The patterns vary from near circular to elliptical and with specific tails towards the direction of travel. At times the smaller satellite stains also break in to parts flying away from the mother drop.

By carefully measuring the width and length of the stain, the angle of impact is determined which helps the agent to reconstruct the event that might have occurred. The Blood spatter or the impact spatter is created when the speed at which the blood leaves the body with the type of force applied to the blood thereby creating a characteristic pattern. For example a gunshot spatter where the forward spatter can be a fine mist and back spatter may have larger and fewer drops. This depends on factors like the type of gun, distance between gun and victim, the specific part of the body hit, if bullet is still in and relative location with respect to adjoining walls, floors and objects surrounding the victim. With thorough investigation the forensic expert can predict possible sequence of events responsible for crime.

“Forensic acoustics deals with acquisition, analysis and evaluation of audio recordings to be used as evidence in an official legal inquiry” – Robert C Maher

There are various types of sounds around us and are indicative of something subtle happening in the background. There are instances that accidents or these related sounds become the subject of investigation- crime. There are many instances like sudden brakes applied to a car, background noise due to a malfunction from aero plane’s airframe, the music being played in the bar playing infringing on a valid copyright, threatening phone calls etc. Forensic acoustics uses principles of physics along with advanced audio analysis to examine and interpret the sound evidence. A wide range of methodologies are used for identification, isolation, separation, study of overlap or any other type of specific sound. A typical spectrogram is a visual representations of sound, displaying frequency, amplitude, and time. In Comparative analysis the unknown audios are compared with already known samples like voice samples or firearms to establish and identify the similarities that can be presented in Court.

Enhancement of sound utilizes signal-processing techniques in an attempt to improve the intelligibility of speech, the clarity that is overall signal-to-noise ratio with specific background sound of the recording. Advanced enhancement techniques use a high-quality digital copy of the original. The final interpretation is presented in form of words, pictures, statistics, and graphs helpful in official investigation of the case in hand. Specific features are extracted from the audio recordings, identifying particular words or phrases in speech analysis for example for isolating gunshot sounds from background noise. The slide below is an example of typical forensic audio recording, with manual annotation, recorded using sound software package ready to be presented in court.

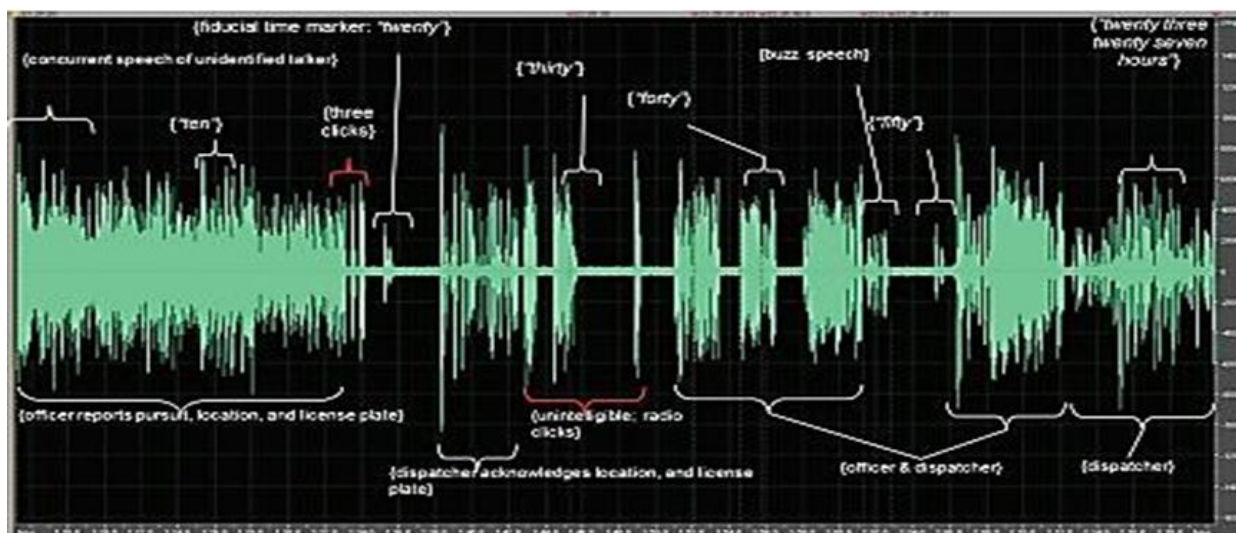

Slide: Example of a forensic audio recording (<https://acousticstoday.org/>)

The applications of forensic acoustics helps in speech and voice analysis in which the recorded conversations like phone calls are analyzed to identify the speaker, to check the speech authenticity for if the tape has been tampered with. The sound analysis using gunshot investigations tell us about the number of shots fired, the type of gun used the direction from where the gun was fired and distance of gun from the recorder. Using advanced software’s, audio enhancements are used to improve poor-quality of audio recordings typically by removing background noise, echoes, or other distortions thereby improving intelligibility for proper investigation. In environmental noise analysis, forensic experts try and identify- quantify sources of noise coming from surrounding like traffic,

construction, industrial equipment helpful in regulating noise pollution. Forensic musicology experts analyzed musical compositions during performances to determine copyright infringement if any.

In crime accident cases we need to know when the car brakes were applied producing patterns of Skid Marks by tires. With the help of these marks one can determine the speed, range of friction, and the force applied when sudden brakes were put. $Speed (S) (mph) = \sqrt{(30 \times Distance \times friction \text{ Coefficient})}$. Physics helps in finding the radius of the blast area, and to locate the point of origin which can then help in finding more debris and can be used as evidence for analysis. Typical explosion scene perimeter = $x + y$ which is equal to $1.5x$ in open space with x as farthest distance from the core at which fragments are located with y as half the distance of x . Also we can calculate the approximate energy released during the blast causing the shockwave. Explosion is seen to create huge amount of gas which travels at speeds of several thousand miles per hour. By investigating damages caused to filled organs and to the walls and nearby objects, the position of person and point of origin of blast can be found together with the amount of explosive used.

In many crime cases shattered or broken glass is found as a very important piece of forensic evidence. Window pieces or glass fractures helps experts to judge the direction, angle and first impact of the gun shot. Different types of fractures thus produced help in locating the direction and point of impact. Because of explosion pieces of glass fly in air nearly ten meter away and its traces may be found in suspect's shoes, clothing or hair. If however a bullet shatters the glass, the breakage pattern carries the information of angle of the trajectory helpful in tracing the position of the suspect when the bullet was fired. Carefully collection and preservation of samples can lead to crucial information of crime at hand.

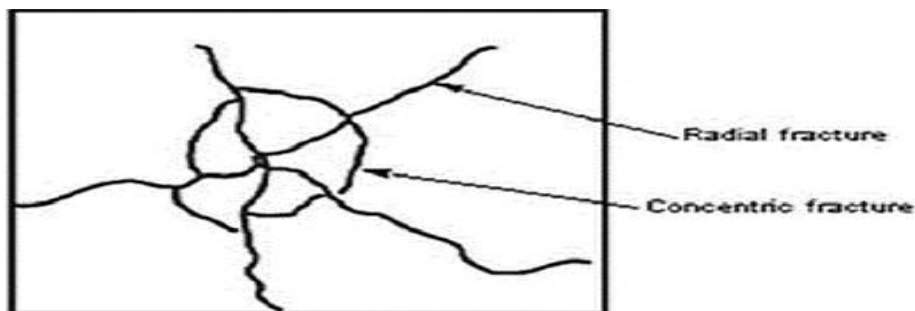

Slide: Glass Fractures hit by a bullet (<https://forensicfield.blog/glass-physical-evidence/>)

Proper photographs at the crime scene as at what distance glass pieces are scattered can tell lot about the crime. As pieces of glasses may be small at times, different methods are in use to find its type based on its refractive index (RI). The density gradient (DG) and the so called Becke Line immersion (BLI) are two popular methods used for comparing the glass evidence. The DG method compares sets of glasses using flotation level in two liquids having different densities and in mixed proportion. If the pieces belong to same single glass frame they float at the same level. In BLI method the glass fragment is immersed in a liquid and if Becke line appears inside the edge it indicates greater RI than the surrounding liquid. Whereas if the glass fragment becomes invisible it means glass and liquid both have identical RI. In more advanced methods temperature variation can be used to measure the refractive index of glass by the Glass Refractive Index Measurement (GRIM).

Most of the microscopic analysis is obtained using a standard microscope with microscopic features which are more individualistic to a specific group. For elemental analysis a Scanning Electron Microscope (SEM) instrument with attached X-ray analyzer is used. Each element emits X-rays of

characteristic wavelengths – energies which are then identified by an X-ray analyzer to detect the elements present in a specimens like paint chips, jewelry, stones, fibers etc. A comparison microscope on other hand is used to compare views of two specimens on single screen. This helps in actual visual comparison of the color of paints, of fibers, and of inks. It is also helpful in distinguishing between the characteristic features of bullets. For birefringent materials in soil glasses and fibres, a polarizing microscope is invariably employed. When a specimen is placed under crossed nicols/ polarized light it produces image having varied colours and intensity contrasts which displaying altogether different features even between slightly different shades. For example the fading away of the same cloth having same shades worn by different people depending on their use, washing and other external factors. The shades of clothing are easily distinguished under polarized light.

Tool Mark Imaging System Database (TRAX) has digital images and associated data which are characteristics of tool like tool angle, the material used to make it, and striation marks made by specific types of tools used in crime. Further the system uses an adaptive zoom algorithm (AZA) for extracting striation features. In Soil analysis the samples are collected from shoes, clothes and vehicles present at the time of crime from specific location. Specimens are then analyzed using XRD, DRIFT method, and Mass and Volume Magnetic Susceptibility. Forensic 3D facial reconstruction is done with computer modelling and other software's with the help of using equations of Physics. Advanced forensic document examination is conducted using light spectrum under Infrared and ultraviolet light, with Raman spectrometer and Video Spectral Comparator.

Bone Fracture toughness, which is the inherent resistance of bone material to fracture is analysed using fracture mechanics. Fracture bone analysis is a complex process and basically involves stiffness of bone is related to elastic or Young's modulus (Y) which measures the resistance of a material to elastic deformation and represents slope of the initial linear portion of a stress–strain curve. Bone strength is a measure of a material's resistance to failure that is the yield strength or the maximum stress that can be applied. Bone toughness measures energy absorption capacity up to its failure and is the measure of area under the stress–strain curve. New analytical and computational models for bone fracture and strength have been developed.

To conceal the crime, the body is most often destroyed or burned. Curved Traumatic fractures are an important part of identifying feature of burned bones which are more commonly referred to as longitudinal and transverse fracture. In such cases, burned bone analysis is carried out which is a step process accompanied by change in colour from dark brown to black to grey to white. Bone colour, the indicator of temperature may vary with the length of exposure, difference in heat and flame interactions and with different inner and outer colour variation. More detailed analysis is carried out using sophisticated methods of characterization like X- ray imaging, X- Ray Diffraction , small-angle X-Ray scattering, Fourier Transform -IR, Micro- CT scan, Micro Structural analysis, BV/TV content analysis, C-I index, thermo gravimetric (TGA), SEM and TEM.

Forensic analysis of drugs uses XRD technique to identify the compound and composition. This technique is used for detection of cutting agents used in illegal drugs. The technique has advantage of being non-destructive and can be performed on any solid sample easily. The analysis is essentially quantitative where by comparing the peak intensities to its standard, the concentration of drugs or any other additional agents like mixture of cocaine & maltose can be found. X-ray micro-diffraction helps in identification of very small amounts like the residues of the container which was originally used to store it.

Powerful and new Raman spectroscopic methods namely Surface-enhanced Raman spectroscopy (SERS) are used in the forensics for the sensitive analysis of trace amounts of controlled substances. Shifted-excitation Raman difference spectroscopy (SERDS) has been utilized to get fluorescence free background in some forensic evidences. Spatially offset Raman spectroscopy (SORS) has been deployed to analyze surface materials like explosives and drugs, directly through surface packaging and container materials without having to open the box. Raman Spectra-Combined methods form more powerful tools for detection of very complicated forensic investigation scenarios. Raman analysis has actually proved to be a powerful tool in the hands of forensic experts.

Fourier Transform Infrared Spectra (FTIR) has been conveniently used for the elemental analysis of forensic evidence such as fibers, paint chips, GSR, etc. It uses typical fingerprint region to identify the fundamental bonds which are unique to every chemical substance. IR is used for tracing the alcohol concentration in individual's breath. Together with Raman Spectra, it forms a cross check tool for identification of remains for example in Arson where much evidence undergoes chemical degradation because of the destructive nature of fire and the accelerants either completely burn or evaporate, and may be present in traces within any of the decomposed materials. Combined FTIR – Raman Analysis is also useful in commonly found household materials. Moreover the complementary nature of IR and Raman spectroscopy are very helpful in analysis of forensic automotive paint to investigative leads from the clear-coat layer of an automotive paint.

Mass spectrometry (MS) was basically developed as a tool for identification of unknown compounds by US Physicist Walker Bleakney in 1929 along with other leading physicists who were instrumental in developing the first mass spectrometer. The most robust instrumental tool namely mass spectrometry which is still considered as gold standard was used for identifying unknown substances, identify drugs inside and outside of our body. Initially its use was limited to gas and inorganic-vapor analysis. In fact in the early twentieth century, forensic labs were hardly aware that this complex, then expensive process would become so popular identification tool within hundred years. As MS evolved, the process became more and more straightforward and less expensive. Scientists started modifying the equipment for analysis of natural products and plant extracts.

A firearms technician in 1959 at the Chicago police crime lab discovered that gas chromatography coupled with MS (GC-MS) tests could be effectively applied to detect whether accelerants were involved in creating fires. Forensic Experts started applying using GC-MS to study gunshot residue and explosives that were found at the crime scenes. The test was so revolutionary that it could detect specific firearms used in violent crimes. Old forensics techniques of detection which were more or less unreliable at times were replaced by more sophisticated GC-MS techniques allowing forensic analysts to gather much more detailed information like gun residue, if the gun was used in the crime. In fact GC-MS technique has been effectively used for explosive detection, fiber and hair analysis in complex crimes. The MS technique also paved a way for advent of forensic toxicology for detection of drugs to the extent of one half-billionth of a gram through person's blood analysis.

Directorate of Forensic Scientific Laboratory (DFSL) in the State of Maharashtra, and Mumbai is a world- class technological institute in the field of forensic dealing with General Analysis and Instrumentation (Narcotics & Explosives), Toxicology, Biology, DNA Analysis, Liquor Prohibition and Excise Duty, Missile Ballistics, Physics, Sound and Acoustic analysis for tape identification and speaker identification (TASI), Computer Crime (Cyber Forensic) and Psychology. With the use of latest scientific equipment and technology, this institute stands in of the leading forensic labs in the country. The computerized long firing gallery measures the velocity of bullets, effective range of the weapon, and firing distance existent during crimes. The associated Projectile Velocity Measuring

System helps to improve the quality, accuracy and speed of the work. The internal gallery also hosts a “Ballistic Gelatin Measuring System”, with attached camera to capture the images of the trajectory of the bullet in the gelatin block fired from the gun. A special software is used to study the paths of bullets and associated cavities created by the bullet in the gelatin block. The Gelatin block mimics the human body and research related to human body can be done using the parameters.

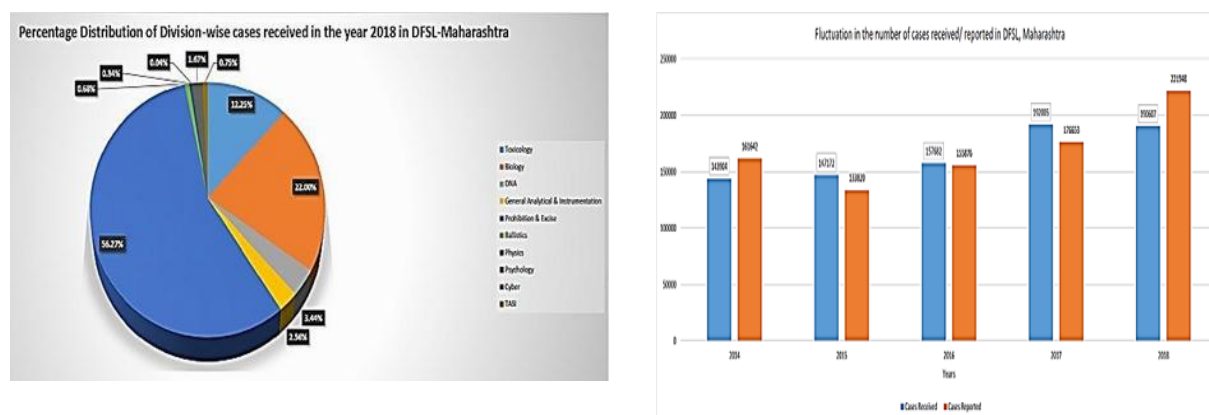

Slide: Forensic Cases received by DFSL (Maharashtra, 2018)

Physics division at DFSL examines soil, paint, glass, metal, fiber, tool marks etc. in various crime cases. Evidence materials collected from site are examined using Atomic Absorption Spectrophotometer (AAS), Simultaneous Thermal Analyzer (STA) and Energy Dispersive X-ray Spectrophotometer (EDAX). Video Spectral Comparator (VSC-8000) is used to identify ink on forged documents such as duplicate-currency notes, facsimile stamps, stamp papers, lottery tickets, certificates and bank cheques. The sound and acoustic analysis includes Video authentication helpful in regulating the integrity of digital video and verifying that the video has not been tampered with. Forensic examinations of videotapes consist of a visual and aural examination using waveform monitor– oscilloscope. The auditory or the sound analysis use computer techniques to detect, recognize or discriminate between different human voices. Forensic speaker identification (FSI) typically involves both aural and spectrographic analysis of the voice. It is carried out using steps like acidification, segregation, clue word formation etc. Spectrographic testing involves testing various parameters such as frequency, pitch, power, amplitude and noise in a voice signal.

Crimes are mostly carried out in lonely places. There is every chance that a crime looks like an accident. Hence reconstruction of events is essential. All angles social and scientific are needed to have a complete picture of what might have happened. For proper judgment the corroborations of results obtained from direct disclosure by the victim and scientific investigations are mandatory. Most of the forensic investigations involve use of Chemistry, biology and some traditional techniques without much focus on Physics. Carrying out investigation with Physics expert can lead to findings that give new information about the case in hand for proper justice. The principles of Physics properly applied for investigation lead to more truthful results. Sophisticated instruments primarily developed with Physics background have applications in all fields of Science and Technology including medicine and forensics. The accuracy and precision of these instruments is unquestionable and results obtained are more authentic and unbiased. With the use of technology based on Physics like cameras, communication networks as well as other detecting devices the crime rate can be kept in control. As the technology progresses, more and more cost effective equipment's can be installed to curb crime and make our society more peaceful.

PHYSICS IN FORENSIC SCIENCE

Vinod Kumar Gupta

Department of Physics, Government Girl's P.G. College, Ujjain

1. Introduction

The story of Archimedes in 287-300 BC is perhaps the first forensic investigation based on scientific principles. By measuring the water displaced by the crown and a piece of pure gold of the same weight as that of the crown he was able to prove that crown of Hiero the king in Syracuse in Greek was made of alloy. Later on Galileo Galilei described that the Archimedes proved this by applying two principles one of buoyancy and the other lever. According to him Archimedes took a balance and suspended crown and pure gold piece from the two ends of it. Then he immersed both the crown and the pure piece simultaneously. The balance was tilted towards the pure piece side proving that the crown was made of alloy. This is an example of application of basic physics principles as forensic technique.

The so called father of forensic science Mr. Edmond Locard a French criminologist has given a basic principle of forensic science that "Every contact leaves a trace" in the form of finger print, foot print etc. This was termed as exchange theory in the field of forensic science. The famous Scottish writer Arthur Conan Doyle created a detective character Sherlock Holmes in 1892 in his famous work Adventures of Sherlock Holmes, with extraordinary property of observation, scientific reasoning and scene recreation that solved so many mysteries. Thus forensic science is mainly based on observation and scientific reasoning which can correlate the events and help investigating agency to arrive at a certain conclusion. Clearly forensic science needs help of scientific tools and equipments. With the evolution of science and technology forensic science also evolved. Thus we use the knowledge and equipments based on physics, chemistry, biology, psychology etc. different branches for forensic investigations.

2. How Physics is used in crime detection?

At the crime spot traces in the form of finger print, hairs, fibers, body fluids and gunshot residue, bullets, clothes, drugs, situation and evidences from CCTV camera are collected, photographed using appropriate technique. All these things are analyzed by the forensic experts and investigating agencies to recreate the scene. To do this forensic analysis of the traces and evidences found at the crime spot, principles and equipments based on physics play a major role, such as microscopes, imaging techniques, spectrometers etc. Different fundamental principles such as Newton's laws, density and refractive index measurement etc. are very much helpful in the investigation.

3. The details of the Instruments/technique used in detection process

A number of instruments based on physics are used in forensic science. The main instruments / techniques are - 1. Microscope/Electron microscope, 2. Mass Spectrometer, 3. Use of the Photoluminescence Phenomenon 4. Use of Ultraviolet Light, 5. Use of X-rays etc., 6. Software-based Imaging Methods for Facial Reconstruction etc., 7. Measurement of Density (soil & glass examination), 8. Refractive index of materials and birefringence for fiber analysis. I will describe them one by one. First one is (1) Microscope – the various types of microscopes such as stereo microscope, comparison microscope, electron microscope, scanning probe microscopes are used in forensic investigation.

3.1 Stereomicroscope

Stereomicroscope has one main objective. Image of which is shared by two intermediate objectives set at stereo angle which is nearly 12° to 15° . The images formed by these objectives seen by two eyes forms 3-D view of the object. Its magnification can be changed by varying the distance of intermediate objectives from main objective. Focus can also be changed. Its magnification can be up to 100X. These are used to identify the fibers, hairs, and pathological study of the samples.

Parts of a Stereo Microscope

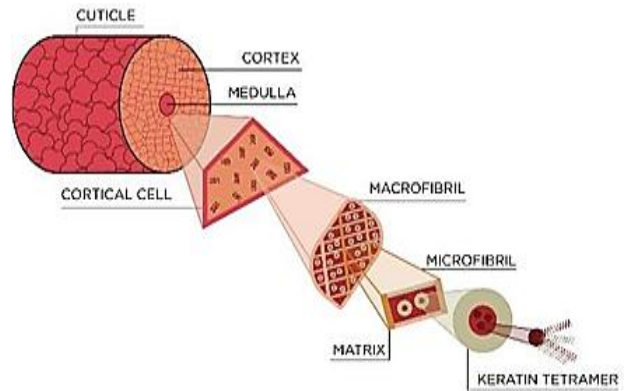
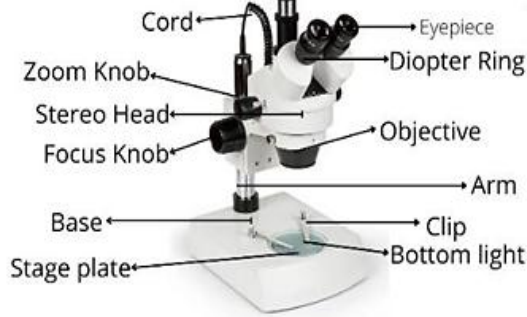

Hair analysis is crucial in forensic science as it remains intact for a very long time. Using stereomicroscope forensic experts examine color texture etc. surface analysis of the hair. A useful parameter called medullary index is determined using laser diffraction method by measuring the diameter of the hair and medulla

$$\text{Medullary Index} = (\text{Diameter of Medulla} / \text{Diameter of Hair})$$

Medullary index is generally greater than $\frac{1}{2}$ for human hair and it is less than $\frac{1}{3}$ for animal



Comparison of human and animal hairs

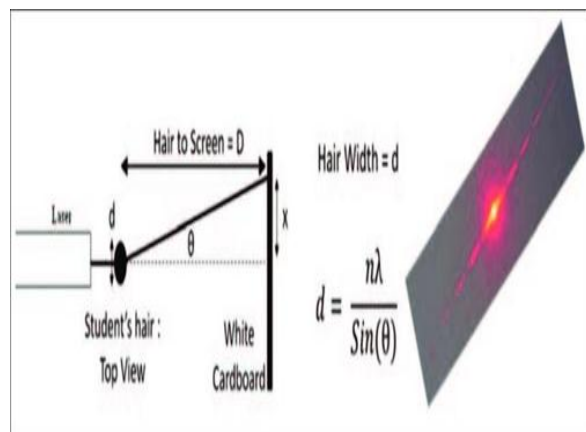

Diameter of hair using LASER diffraction

3.2 Comparison Microscope

Comparison microscopes consist of two microscopes side by side connected by an optical bridge to form the images in a split window so that one can compare the two images. On the basis of comparison the forensic experts are able to say that the two samples under examination are of same origin. For example comparison of bullet fragments, cartridge cases and other samples experts can say that the bullet is shot by which gun. Any bullet fired from a particular gun revolves inside the barrel grooves and make specific marks on the bullet. Comparison of the two bullets using comparison microscope it

can be established that the bullet was fired by a particular gun. It can also be used to identify pollen grains, hairs and diatoms etc.



Bullets comparison



Comparison Microscope

3.3 Electron Microscope

Optical microscope sets a limit for forensic analysis of the samples by their magnifying power and resolution. Magnification of these microscopes is limited to 1000X - 1500X and resolution about 600 nm in axial direction and about 200 nm in lateral direction. The limit of resolution is set by the wavelength of the light used. It can not be more than $\lambda/2$. Wavelength of electron beam is 10-12m while that of visible light is of the order of $4 \times 10^{-7}m$ to $7 \times 10^{-7}m$ so the magnifying power of electron microscope is 10³ times more than the optical microscope. Resolution is also better. These things help in revealing the finer details of the samples to the forensic experts. Electron microscopes are of two types mainly one is Transmission Electron Microscope called TEM and another is Scanning Electron Microscope called SEM.

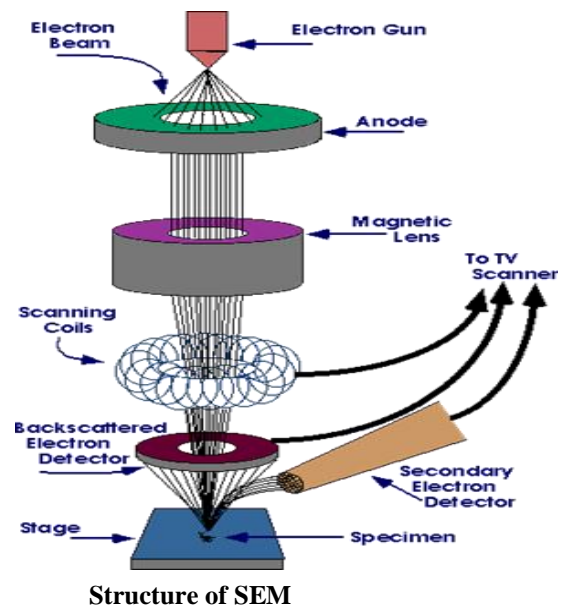
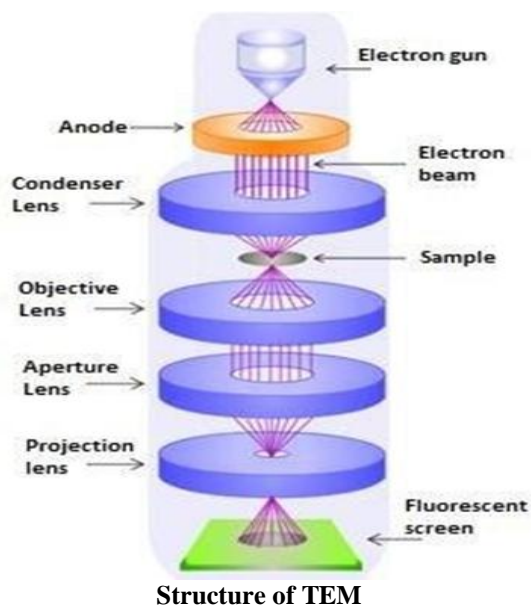

In both microscopes electron gun and magnetic lenses are used. In TEM the focused beam is incident on the sample and transmitted beam is analyzed by using a fluorescent screen. The electrons transmitting through the sample interact with the sample electrons. These interactions may lead to X rays, secondary electrons, scattered electrons; back scattered electrons etc. with reduced kinetic energies. These are incident on fluorescent screen or CCD camera to form the final image. Thus a 2D image is formed which gives information about the interior of the sample. In SEM the electron beam passes through the scanning coils. This beam scans the surface of specimen and forms an image revealing surface structure. Any criminal leaves traces at the crime spot in many forms. The Electron

microscopes are used for the trace analysis of fibers, fake documents, fake currency, gunshot residue analysis, handwriting and printing analysis etc.

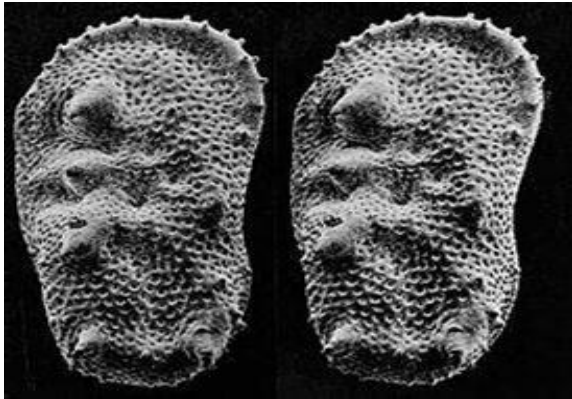

SEM stereo pair of microfossils



SEM image of human hair

4. Mass Spectrometer

Mass spectrometers are used in forensic science to identify any known or unknown material. If a rare material is found at the crime spot it can be identified using this spectrometry. The identification can establish firmly crime spot or other related findings. In the mass spectrometry a sample is introduced in the spectrometer then vaporized and ionized using electron beam. This ionized beam is passed through the magnetic mass analyzer. Lighter ions are deviated most and heavier ions least. Analysis of these ions using a detector gives us the charge to mass ratio. It is used for toxicology, drugs, explosives, flammable compounds etc. Mathematical analysis -First the ions are accelerated by electric field,

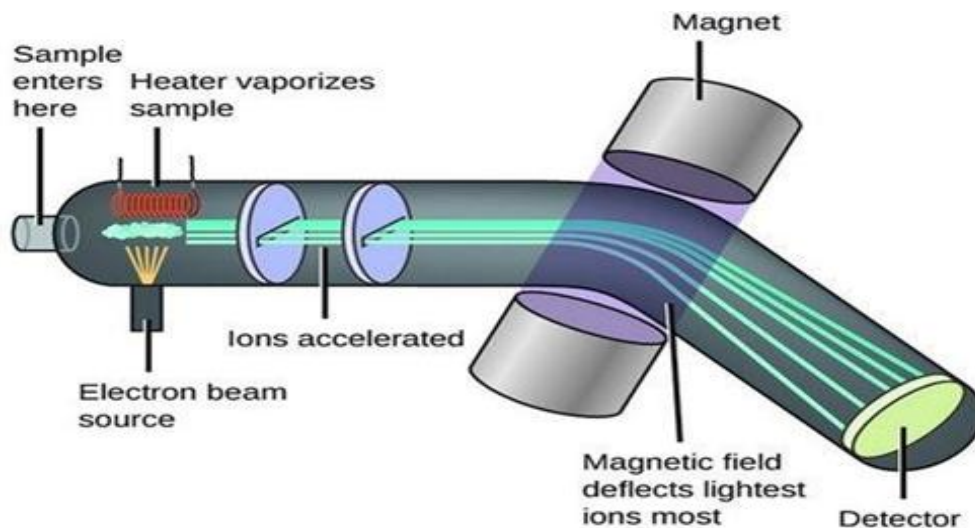

let ion charge is z and electric potential is V then

$$z V = m v^2/2 \quad (1)$$

These ions when pass through the magnetic mass analyzer the Lorentz force produces circular motion, the governing equation for it is

$$B z v = m v^2/ r \quad (2)$$

Where B is magnetic field and r is radius of the circular path. Using the two equations

$$z V = m (B z r /m)^2 /2$$

$$m/z = B^2 r^2 / 2V$$

Mass to charge ratio is determined by measuring B , r and V . This gives composition of the material.

5. Photoluminescence Spectroscopy

Photoluminescence spectroscopy consists of luminescence produced by incident light photons. Incident photons excite the molecules of the material to excited states. From these excited states the molecules come to ground state and emit the radiation of longer wavelength. Fluorescent materials de excites immediately and emits radiation while phosphorescent materials de excites after a long time and emits radiation.

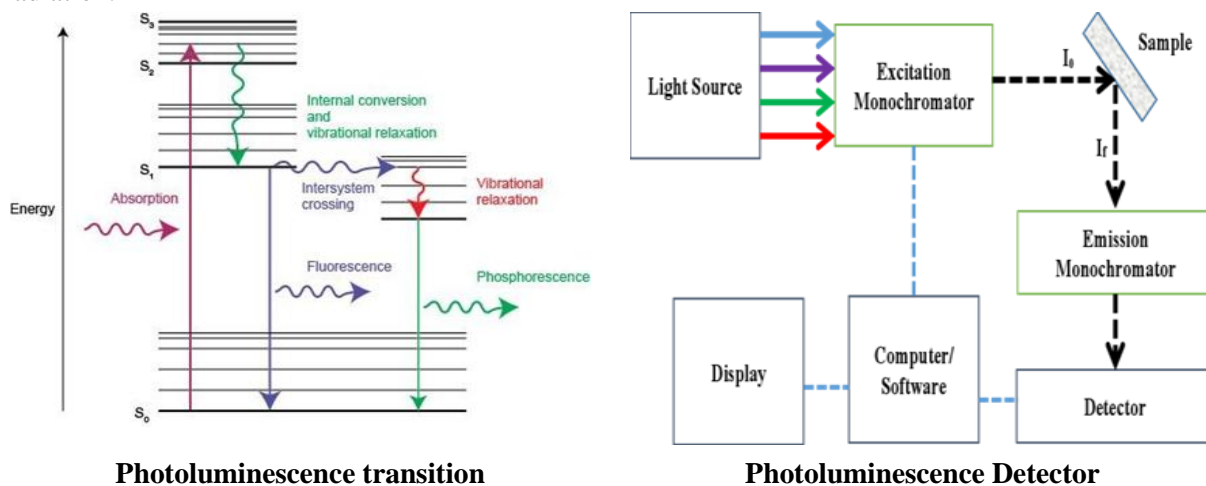

In forensic science this technique is used by the application of a detection fluorescent powder on the papers, currencies, hand bags etc. If these things are touched by the criminals then their hands when viewed under ultraviolet light give fluorescence. Some common organic compounds which have been used for powders are acoumarin6, acridine yellow, acridine orange, crystal violet, Nile blue, Rhoda mine B and Rhoda mine 6G. This technique is also used to identify artificial gems as some of the artificial gems show fluorescence. Some drugs also show photoluminescence so it is helpful in identifying drugs. It is also used in finger print, gunshot residue, documents analysis Image under white light and PL map of it clearly shows use of two inks to make 3 to 8.



6. Use of Ultra Violet Light

Visible region is from violet to red color ranging from 400 nm to 700 nm. Ultraviolet light is of wavelength less than 400nm. Advantage of UV light is that it gives more contrast and clarity to wounds, injuries and bite marks when viewed under UV light. Infra-red light which has wavelength greater than 700nm is also used in forensic science to identify the compounds. This is done by IR absorption spectroscopy. Figure shows latent fingerprint under Reflective Ultra Violet Imaging System (RUVIS).



Latent fingerprint by RUVIS



Drug particles under UV light

7. Use of X-rays

Use of imaging techniques such as X-rays, ultrasonography and MRI are useful in forensic science. X-rays are electromagnetic rays of wavelength ranging from 1 to 10 Angstrom Unit. These rays have a unique property of forming image of the inside organs of the body and bone structure. X rays reveal the bone cracks, injuries clearly. X rays can also identify the metallic or nonmetallic contraband inside the human body by scanning. X-rays is a versatile tool in the field of forensic science. Computerized tomography scan called CT scan is useful to detect the injury in a specific part and its depth. Advanced CT scan and Magnetic Resonance Imaging called MRI can form 3 D image of the dead body to do noninvasive digital autopsy with the advantage that evidences are not altered in PM.



X ray image of a contraband in a bag

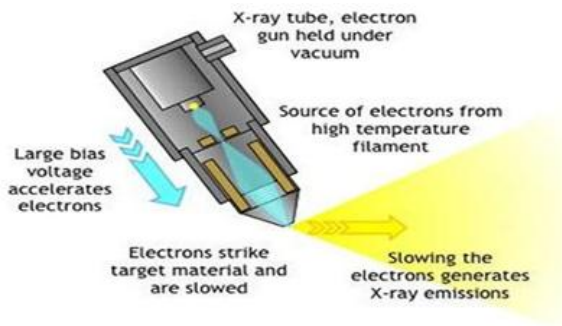

Portable X ray source



3D Computer assisted virtual autopsy



Virtual Autopsy image on LCD

8. CCTV Cameras

CCTV means Close Circuit Tele Vision. These cameras are installed at different places and at different angles which capture video of the place and records in the hard disc and broadcast in a limited premises. This is helpful in identifying any criminal, thief entering with time. The cameras are of mainly two types bullet cameras and dome cameras. Nowadays PTZ cameras are also developed. PTZ stands for Pan means rotate, Tilt and Zoom.



Bullet and Dome Cameras



A PTZ camera

9. Software Based Imaging Methods for Face Recognition

Face recognition is a technique of identifying a certain person from the available photo or video. In this technique data are collected by mapping the face according to 80 nodal points. Nodal points are specific property of the face which does not change with age for example – nose length, depth of eyes, distance between eyes, shape of cheek bones etc. These are called nodal points. Measurements of these nodal points are stored in the form of numerical data. This data is now matched with the available database of faces for face recognition. Earlier 2D images were compared that can miss exact matching due to change in angle of photographed face. Now advanced 3D modeling technique is used for face recognition. Computer software developed uses deep learning algorithms. At present Artificial Intelligence based software use deep learning algorithm, computer vision and image processing. Thus the whole face is compared and not the individual features.

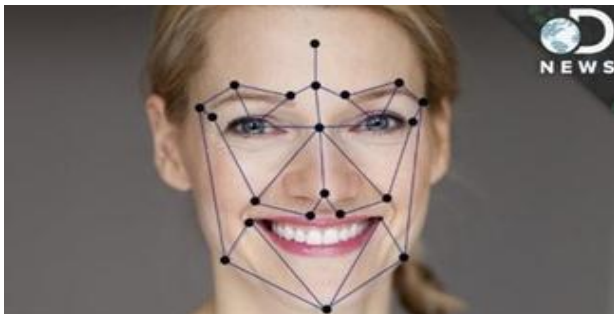

Few Nodal Points for Face Recognition



Density and R.I. is Used to Identify Original Glass

10. Measurement of Density and Refractive Index of Glass

It is a common incidence that broken glass is found at the crime spot. It may be a window glass of vehicle or building or drinking glass. Different Glasses have different densities ranging from 1.5 to 7gm/cc depending on the type of glass and refractive indices. So the measurement of density and refractive index of glass fragments found at the spot may help in identifying the origin of glass fragments. Density of the glass is found by using the water displacement and floatation technique. Refractive index is measured by observing glass fragments under Phase Contrast Microscope (PCM). Refractive index of glass depends on the quality of glass, temperature and wavelength of light used to illuminate the specimen. RI is inversely proportional to wavelength and inversely proportional to temperature. Glass fragments are immersed in silicone oil and put on a glass slide. This specimen is viewed through PCM. Temperature of the oil is changed slowly to change its RI. When the RI is equal to RI of glass fragments edges of glass are not distinct. This is called match point. At other temperatures contrast is more. Basic principle of PCM is that when a light ray passes through a

material phase of un-scattered light changes while that of scattered remains same. Interference of these two converts the phase into brightness.

Refractive index by immersion method.

Immersing a glass particle in a liquid medium (silicone oil) whose refractive index can varied with temperature until it is equal to that of the glass particle.

At this point, known as the match point, the Becke line disappears and minimum contrast between liquid and particle is observed: $RI_{oil} = RI_{glass}$.

The Becke line is a bright halo near the border of a particle that is immersed in a liquid of a different refractive index.

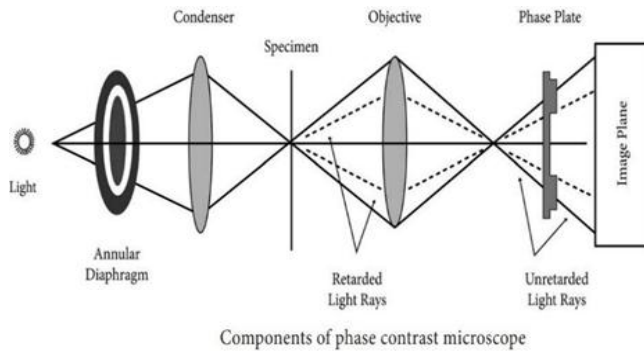

11. Soil Density and Composition Measurement

Soil is the important trace evidence in the analysis of the forensic investigation. Soil dry or wet, easily stick to the humans, animals and other things at the crime or accident spot. The composition of soil and its density, changes from place to place. Therefore, composition of the soil and density parameters may identify the correlation between the place of event and the concerned criminal. Presence of local materials specific to a place is found by using stereomicroscope to identify sawdust, bones, leaves etc., Polarized light microscope and XRD to detect the presence of crystalline solids.

12. Location Tracing by GPS system: A set of satellites records the position of the object. Then analysis of image gives location.



With 3 satellite spheres, left with two possible position reject unfeasible position to determine location

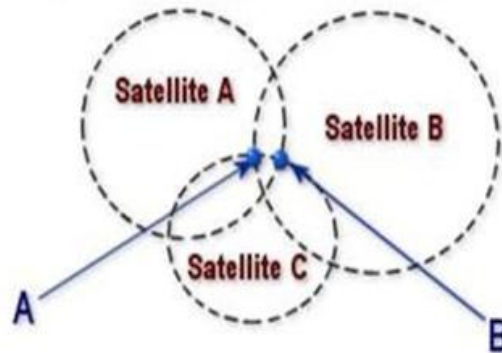

13. Types of crimes

Usual types of crime include mainly theft, robbery, smuggling, personal attacks, crime against woman and children etc. With the digitalization and use of mobile phones newer types of crimes are happening these are computer virus, phishing, hijacking, salami attacks, data stealing, data modification etc. Similar crimes attached to mobile phones also are happening. Apart from these, criminals try to use techniques such that their act can not be traced by the police or the investigating agency. In such situations scientific equipments, techniques and tools play crucial role. Government of India has established Central Forensic Science Laboratories (CFSL) all over the country at 7 places. These are situated in New Delhi, Chandigarh, Pune, Guwahati, Bhopal, Hyderabad, Kolkata. These labs use

scientific equipments to establish a definite linkage between the crime and criminal a major role in forensic investigation.

14. Data of various crimes in last years

Two data charts, shown here shows that in case of usual crimes corruption is highest while robbery and attacks are on second and third position. In case of cybercrimes, we see that in the beginning rate of increase is slow while in later years rate increased abruptly.

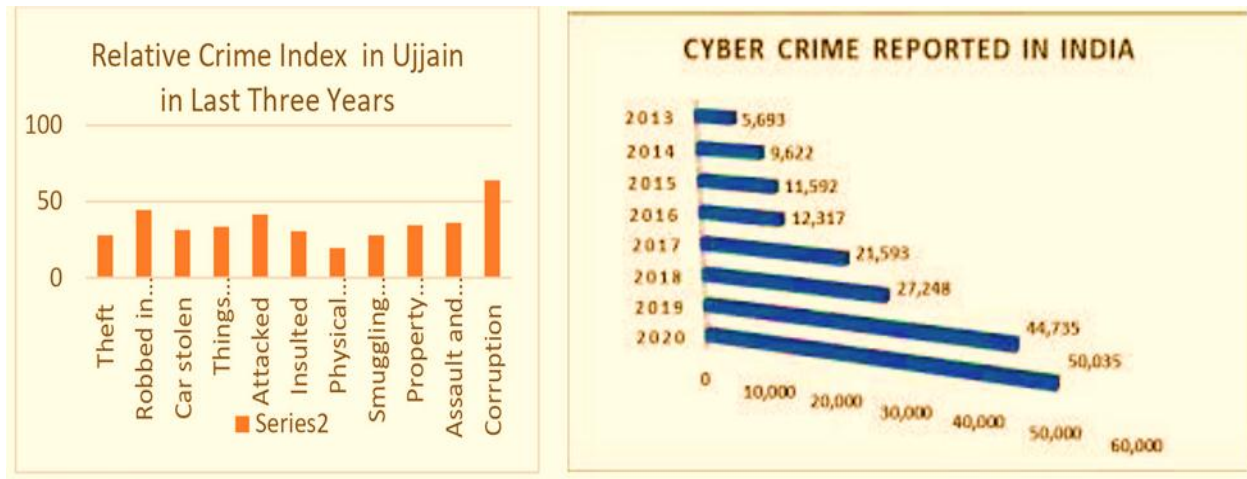

15. Conclusion

Forensic investigation of crimes is at present highly technological and becoming more and more precise using the advanced techniques and instruments. Still the crime world is posing new challenges before us in two different areas. One is the way of crime such that the criminals can not be identified because of their extreme care of not to leave any evidence or trace and another one is cyber-crime of several types. As the technology development takes place, strict laws are framed and security codes are invented, they also find new type of cyber-attacks. To meet these challenges the answer lies in the use of modern scientific techniques and knowledge of new inventions. New technologies have to be used in the forensic world to find the answer to these questions. We summarize below new techniques to be used in the field which are related to physics

15.1. Nanotechnology: Nano sensors may find a wide variety of applications in forensic science. These are small sensors that can determine physical properties of the materials and generate a signal. This can be helpful in forensic material properties determination. As the Nano-materials have different properties than bulk these may prove to be more efficient.

15.2. Artificial Intelligence: It is simulation of human intelligence process by computer. Artificial Intelligence has been used in forensic science in face recognition and finger print analysis etc. process but to harness the AI fully is yet to be explored.

15.3. Carbon Dot Powder: This is a new type of powder which when applied to the finger prints these show fluorescence in Ultra Violet light.

15.4. Foldoscope: Foldoscope is a foldable paper microscope, easy to carry and use at once at the crime spot. Though the information gained by it is primary but it is useful in taking a quick decision and plan further action.

15.5. LA-ICP-MS: LA-ICP-MS is Laser Ablation Inductively Coupled Plasma Mass Spectroscopy is a method to determine the composition of the materials. This method is sensitive enough to find the structure of a very small glass fragment.

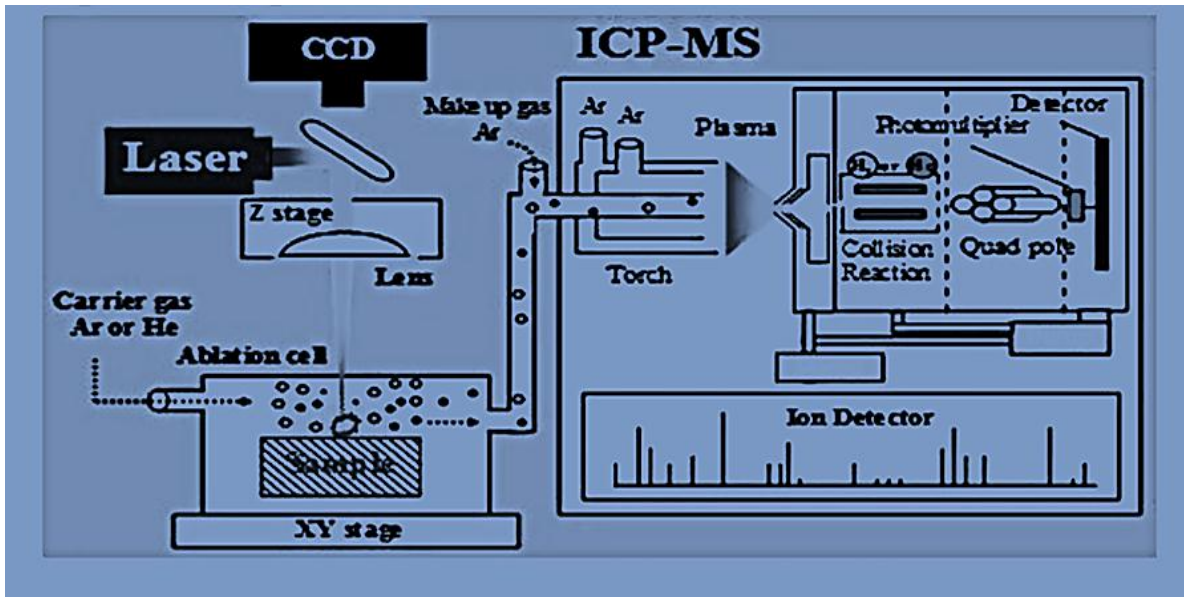

PHYSICS IN FORENSIC SCIENCE

Karishma Sharma

TGT-Physics, Shiv Nadar School, Noida

Key words: Forensics, Trace Impurities / elements, Radioactivity, Fluorescence, Spectroscopy.

About 60 years ago, on November 22, 1963, the United States grieved the death of an iconic and profoundly influential president of all time, the shock of which sent reverberations throughout the world. John Fitzgerald Kennedy, the 35th president of the United States, met his tragic end during a political trip to Dallas, Texas. He was struck by two bullets while interacting with the public in a motorcade— one in the upper back and the other in the head. He was immediately taken to the hospital where, despite immediate medical attention, he was pronounced dead. The Governor, John Kennedy was seated in the same car and the incident resulted in him being wounded by a bullet. Promptly responding to the situation, the Warren Commission and the FBI took over the investigation of the case. The car was examined to find the number of bullets. This isn't as easy as it seems, contradictory to the depictions in nowadays televised crime investigation shows. It is because bullets can fragment upon impact, i.e., they can break into pieces when they hit a target, making it difficult to piece them together to find the true number of bullets that were fired at the scene. In this case, as well, no intact bullets were found, but fragments.

Neutron Activation Analysis of the Bullets: Assassination of the former U.S. president, J. F. Kennedy

How can we put these fragments together and work out the total number of bullets? For that, we must understand what bullets are made of.

Most bullets have a bulk composition of Lead γ and the remaining 1% constitute “trace impurities” that include mostly Silver and Antimony. These trace impurities play a very important role in identifying where the bullet came from. These trace impurities differ from one batch of bullets to another batch of bullets, which makes the identification of the source supplier of the bullet easier.

At the crime scene, multiple fragments were found. During the investigation, they were ground into 5 categories based on the concentration (in ppm) of Silver and Antimony in them.

Fragment	Ag / ppm	Sb / ppm	Sample Description
1	8.8 ± 0.5	833 ± 9	John Connally - Stretcher bullet*
2	9.8 ± 0.5	797 ± 7	Fragment recovered from Connally's Wrist
3	8.1 ± 0.6	602 ± 4	Large fragment recovered from the car
4	7.9 ± 0.3	621 ± 4	Fragment recovered from Kennedy's brain
5	8.2 ± 0.4	642 ± 6	Fragment recovered from the car

* called so because it was found lying near Connally in the hospital.

High levels and approximately close values of concentration of Antimony indicate that fragments 1 and 2 came from the same batch of bullets.

Lower levels of Antimony and values of concentration close to one another indicate that fragments 3, 4, and 5 came from another bullet.

Following are the 3-D mapped images of the bullets and the fragments recovered during the investigation.

Image Credit: NIST, Wikimedia

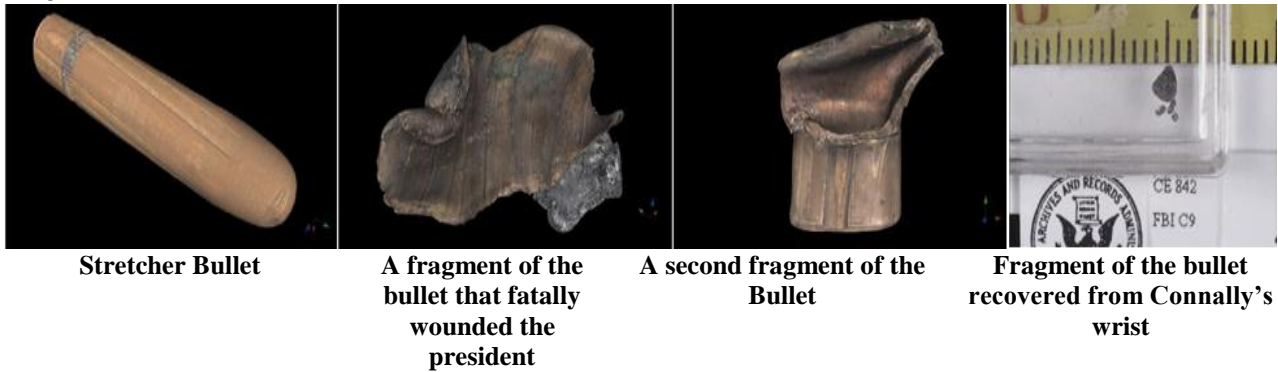

The above results obtained were a result of Neutron Activation Analysis. It is a technique that helps determine the elemental composition of any given substance as well as its concentration - here they were the bullet fragments.

Neutron Activation Analysis (NAA) of the bullet fragments involves them being bombarded with neutrons, which renders them radioactive. How? Like electrons can excite from one energy level to another upon absorption of energy, neutrons of the elements present in the sample can also excite to a higher energy level, rendering them unstable. To gain stability, it decays and gives out γ radiation until it becomes a stable nucleus that cannot further decay. These γ radiations are characteristic of elements present in the sample. The rate of emission of γ rays from these elements helps determine the concentration of that element in the sample since they are directly proportional. For the same, Gamma Ray Spectroscopy is utilized.

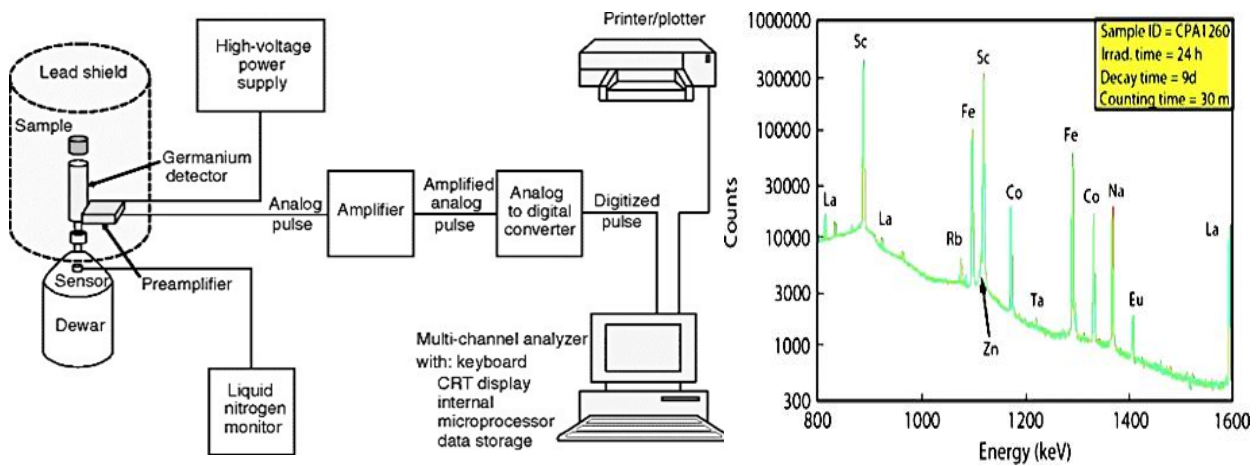

Image Credit: Springer

Image Credit: NTU

In the above set-up for the NAA, the dewar supplies either acetylene oxygen / nitrous oxide to the flame. The sample's neutrons get activated and get excited to release γ radiation that is detected by the germanium detector. Germanium detectors are used to provide excellent energy resolution i.e., they can help detect the energies of the gamma rays emitted by different constituents of the sample accurately. The ray data collected by the detector is used to construct a gamma-ray spectrum using Gamma Ray Spectroscopy, which is a visual representation of the energy distribution of gamma rays as emitted by the radioactive sample, as shown in the image above for a random sample studied using the NAA.

The above investigation confirms that only two bullets hit the car. The eyewitnesses provided the potential location of the shooter as he fled from the crime scene. He was apprehended and subsequently arrested from a nearby movie theatre where he took refuge. The suspect was Lee Harvey Oswald. The rifle in possession of the Lee Harvey was taken in for further analysis by the forensic ballistics team to confirm if the bullets were fired from the same rifle - the results were affirmative. The tests performed were - Comparison Microscopy and Tool-Mark Analysis. (See Next Page for further details related to the two tests)

Comparison Microscopy and Tool Mark Analysis: Did Lee Harvey Oswald kill President Kennedy?

Comparison Microscopy is a technique used in firearms investigation that visually compares and analyses bullets and cartridge cases.

This technique makes use of a comparison microscope (picture on the right) that is designed to give two separate optical paths allowing two specimens - here the recovered bullet and a test-fired bullet— to be viewed and examined simultaneously.

The forensic examiner analyses various aspects of the bullets such as rifling marks, lands and grooves, and other imperfections. These features are compared and scrutinized for similarities and dissimilarities.

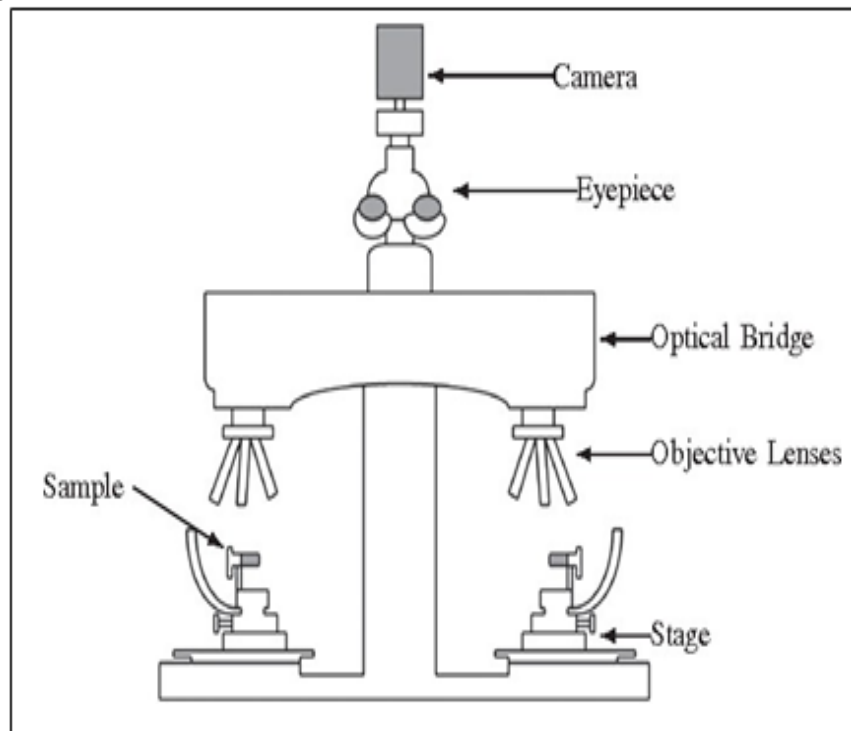

Image Credit: Semantic Scholar

Tool Mark Analysis

- **Rifling Marks** - To identify the firearm used in a crime, the marks left on the bullet by the barrel of the rifle, as it passes through it, are analyzed and compared with the rifle in question. The spiral grooves inside the barrel impart a unique pattern of lands and grooves on the bullet. This pattern is like a fingerprint, as no two firearms leave the same set of marks on a bullet. The rifle possessed by Lee Harvey was examined to see if the striation marks inside the barrel were responsible for the pattern - which includes the number, width, and direction of lands and grooves on the bullets recovered. The results came out to be positive.
- **Weapon imperfections** - Dents, scratches, or other distinct markings on a firearm could impart certain irregularities in the lands and grooves of the barrel and consequently leave unique marks

on the bullet as it passes through it. This could be presented as a strong connection of the bullet with the firearm, and hence, the shooter.

- **Cartridge Case Examination** - Tool Mark Analysis also involves analysis and examination of cartridge cases that includes the firing pin impressions, extractor and ejector marks, and breech face marks to establish consistency with the firearm in question. Used cartridges were found at the location where Lee Harvey was located at the time of the assassination. The marks on the recovered cartridges were compared to the marks obtained on the test-fired cartridges, which confirmed that they belonged to the rifle in possession of Lee Harvey.

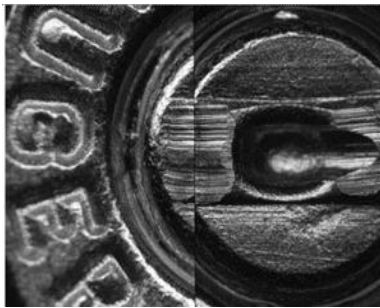

* Two test-fired cartridge cases from the same firearm compared side by side using a comparison microscope. The marks from each cartridge show significant correspondence

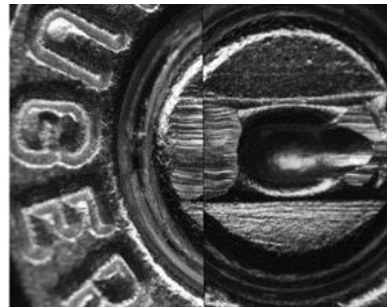

* Two test-fired cartridge cases from two different manufactured firearms. The marks from each cartridge in this image lack significant correspondence

** Credit of the images: crime-scene-investigator.net*

During the investigations, another evidence came to light. It was concluded that the same firearm was also used to kill Army Major General Edwin Walker during the failed attempt at his residence in Dallas, Texas.

Emission and Absorption Spectroscopy

Suppose you have a sample and you pass a beam of light/radiation through it with the detector on the other side. Light will not be absorbed by the electrons within the atom till the energy matches the energy difference between any two energy levels. Once absorbed and the electron has reached the excited state from the ground state, the intensity of light coming out of the other side of the sample drops at that very instant. As the frequency continues to increase, the intensity of the light goes back up. The drop in the intensity is characteristic of the element present in the sample - represented by dark bands in the spectra obtained.

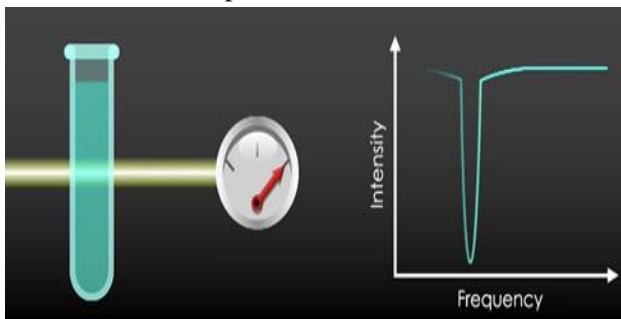

Absorption Spectroscopy

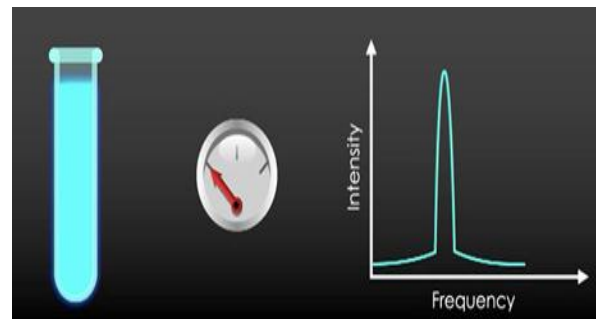

Emission Spectroscopy

Emission spectroscopy is the opposite of Absorption spectroscopy— in this case, the electrons have transition from an excited state to a ground state, during which the energy is emitted that matches the difference between the two energy levels. The increase in intensity is a characteristic of the element present in the sample - represented by colored bands in the spectra obtained.

Since there are many electrons present in an atom, in different energy shells, multiple emissions and absorptions happen simultaneously - that give rise to multiple dark and colored bands in the spectra respectively - which is a characteristic of an element - much like a fingerprint. For example, the below emission and absorption spectra are unique for given elements.

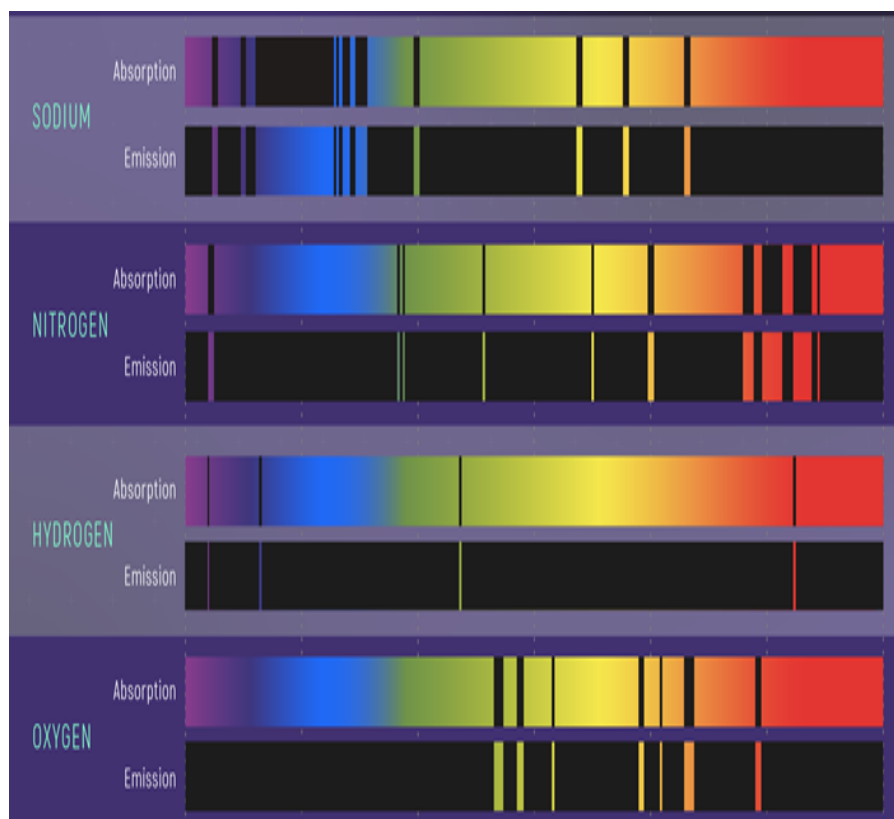

Image credit- webstelescope.org

SEM-EDX (Scanning Electron Microscopy with Energy Dispersive X-Ray Spectroscopy): Unraveling Napoleon's Death

Napoleon Bonaparte, a famous French military and political leader, rose from the position of an artillery officer and a few years later proclaimed himself to be the Emperor of the French. His empire expanded across Europe but faced defeat at the Battle of Waterloo and was exiled to St. Helena, where he died in his fifties. Rumors of murder circulated, although exhumation was prohibited, leaving no conclusive evidence.

More than a century after he died in 1952, some of his hair samples - that were cut off and kept as a souvenir following an old tradition - were analyzed using the Neutron Activation Analysis, revealing the presence of Arsenic - a poisonous element. The conclusion emerged that he was potentially assassinated through arsenic poisoning. Motives pointed to the British, who incurred substantial expenses during the Napoleonic Wars and the French government since they were adversaries.

In 1980, a peculiar question about the color of Napoleon's wallpaper was posed on a radio show by a British Chemist – Dr. David Jones. A stranger responded, claiming to possess a piece of the wallpaper. The significance lies in the suspicion that arsenic may have been present in the wallpaper, rather than ingested through food or drink. Dr. Jones sought to confirm that the wallpaper's color was green which in the 19th century, was achieved using Copper Arsenite.

In SEM-EDX, the sample - here the piece of wallpaper - is placed on the stage and is bombarded with a focussed electron beam given out by the electron gun. These electrons when they hit the atoms of the sample, produce secondary electrons, backscattered electrons, and characteristic X-rays.

The secondary electrons (low-energy electrons emitted from the surface) and the backscattered electrons are detected to create high-resolution images of the sample's topography. Simultaneously, EDX collects and analyses the X-Rays emitted by the sample. These X-rays correspond to the elements present in the sample and carry information about their elemental composition. The EDX detector measures the energy and intensity of X-rays, allowing for the identification and quantification of elements in a given sample.

The anode helps in accelerating the electron beam while the magnetic lens helps focus them onto the sample.

Upon analysing the X-ray spectra obtained through SEM- EDX, it was confirmed that the piece of wallpaper had copper arsenite in it.

How are X-Rays generated in SEM-EDX?

An atom consists of a nucleus that contains protons and neutrons, with electrons orbiting it in distinct energy shells. These electrons can have transition to higher energy shells by absorbing energy equivalent to the energy difference between the two energy levels. This can render the atom unstable. Thus, to attain stability, the electron will drop down to its original energy shell, releasing energy equal to the energy absorbed.

In SEM-EDX, electrons hitting the sample can cause the ejection of electrons from the lower energy levels of the atom. To restore stability, a higher energy level electron drops down, emitting high-energy X-rays. In this picture, Ex is the energy provided by the external stimulus that is absorbed by the electron, following its ejection from the atom. To regain stability, the electron from the M-shell drops down to fill the vacancy, giving out X-radiation.

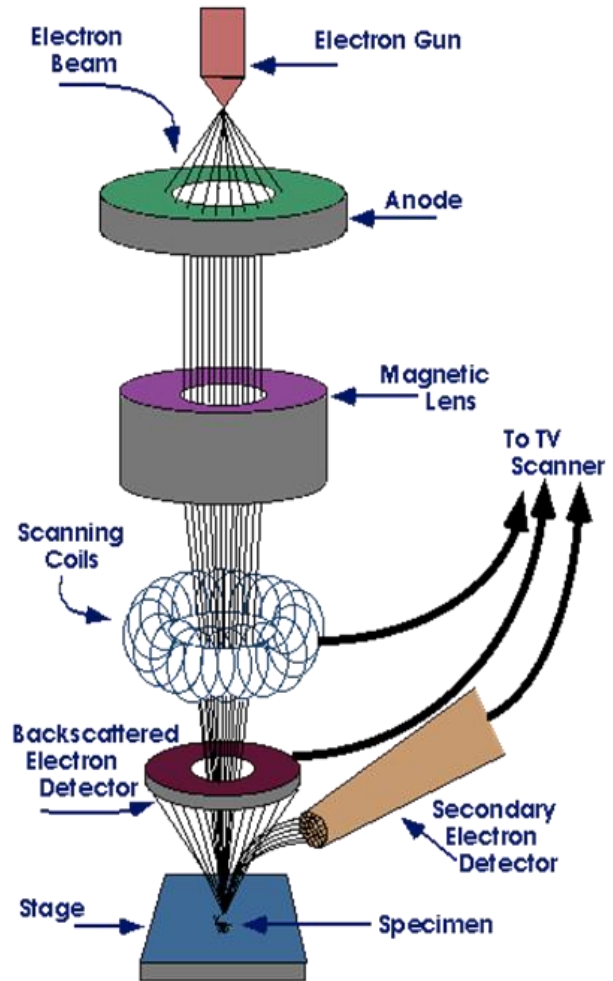
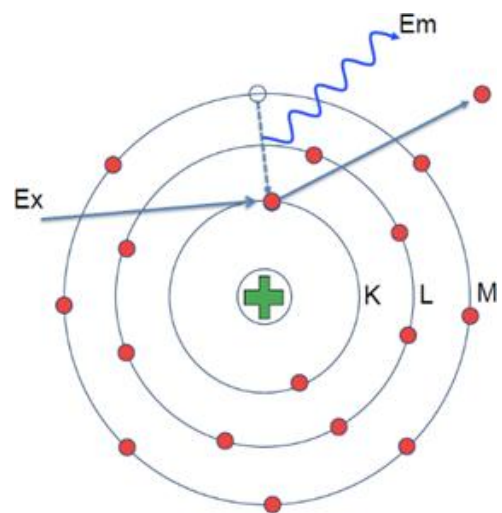

Image Credit: Purdue University



How did Napoleon die? — The climate at St. Helena’s used to be warm and humid enough to provide a breeding ground for molds, some of which were capable of digesting arsenic and others capable of converting it into Arsine gas. It is speculated that Napoleon inhaled this gas, leading to arsenic poisoning. However, the autopsy attributed his death to stomach cancer. The medication used in that era to treat cancer, containing highly toxic mercury chloride, further complicated his health. As a result, his death remains a mystery.

Blood Spatter Analysis

Blood stains and spatters at the crime scene as well as on the suspect can help in reconstructing the crime scene. The way that the blood is distributed can tell you where the blood came from and how it got there.

Arteries carry blood away from the heart and when severed, it may lead to characteristic spatters on surfaces like walls. Blood flowing through the arteries doesn’t follow a continuous path, but rather with every heartbeat, (indicative of blood being pushed out of the heart), the blood will spurt out, which gives a splash of blood as on the wall as in the picture. Since, arteries are broader and carry more blood, with every spurt, a lot of blood is ejected which can be seen dribbling down the wall. If the person has a smaller wound, then you get a pattern of blood drips while you’re standing and wondering what to do next. The exact pattern will depend upon the surface in question and for how long the person stands there with the blood dripping into the pool.



Image Credit: NTU



Blood patterns vary based on the intensity of the event. Low-energy events such as ordinary fights result in low-velocity spatter like blood dripping or being cast off. Even if an assailant strikes someone with a weapon and withdraws the weapon momentarily to strike again, low- velocity spatter occurs.





Blunt force injuries, like those from a baseball bat, create medium- velocity blood spatter as shown on the left. Gunshots, being the most energetic, results in high-velocity spatter with fast-moving, small droplets resembling mist.

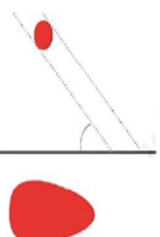
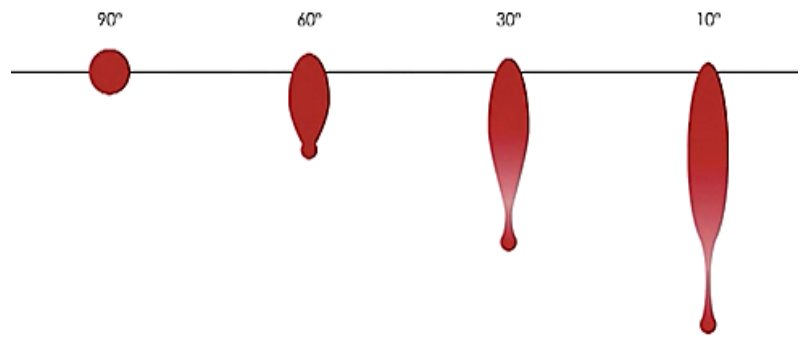

Image Credit NTU

Let’s consider freely-falling blood drops. A freely-falling drop of blood is nearly spherical.

 <p>If the blood drops at an angle of 90 degrees, then it gives a circular spatter mark.</p>	 <p>If it doesn’t hit the floor at an angle of 90 degrees, then it gives an elongated shape.</p>	<p>If the blood that hits the floor has high energy, then along with the elongated shape there will be extra dots of blood that bounce off from the main droplet.</p> 
---	---	---

We can correlate the shape and length of the droplets with the angle with which it strikes the floor, for instance. As the angle becomes smaller and more acute, the shape obtained is relatively more elongated as shown in the adjacent picture. 0° Angle with the floor forms the most elongated shape compared to the other higher angles.



Crime scenes aren't very simple to decipher if you have blood stains in every direction.

We can work out the origin of those blood droplets by plotting lines backward. Where all lines converge, it is the point of convergence, which is very hard to find if you find a lot of blood at the crime scene. Plotting lines backward gives us the height above the ground at which the target was hit. If it's high enough, it can give an idea if the victim was standing or not when he was hit. A few inches off the ground indicate that the victim was already on the floor when he was hit.

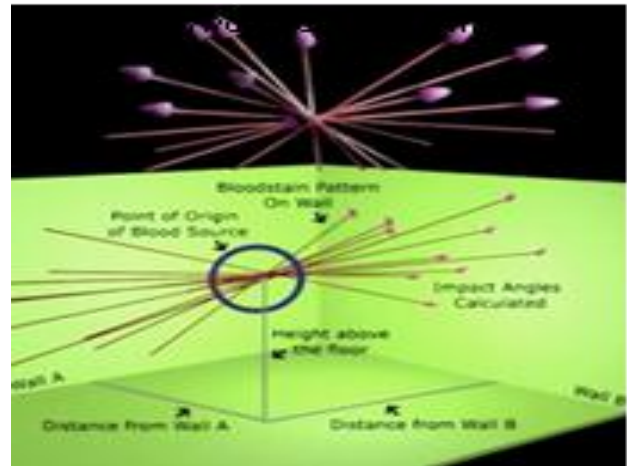

Image Credit: NTU

Fluorescence Microscopy

It's easier to investigate dead bodies than human skeletons for the amount of information they can provide us to solve a crime scene. However, fluorescence microscopy can help us determine whether the skeleton is decades or centuries old, or a few years old. Bones absorb certain elements such as strontium, uranium, fluorine, etc., from the environment (depending upon the geochemistry of that location) in trace quantities as they age, which fluoresce under UV light (absorbing UV light and give off visible light). The wavelength of the UV light used depends upon the characteristic absorption and emission wavelengths of these trace elements. A fluorescence microscope is used to observe the light emitted by the bone sample, the emissions are captured and measured. A calibration curve is constructed that includes the fluorescence samples of the bones of known ages for correlation and estimating the age of the skeleton.

Laser Fluorescence to identify latent fingerprints: Fingerprints are made up of metal salts such as sodium chloride, proteins, and amino acids, fatty acids, water. However, water doesn't stay for long since it evaporates. Certain fatty acids and proteins as well as amino acids can fluoresce under laser excitation.

External Ballistics

This phase of ballistics deals with the factors that influence the trajectory of the projectile, including muzzle velocity (the speed at which the projectile leaves the firearm's muzzle), aerodynamic properties of the projectile, which affects the drag and stability in flight, resistance encountered during flight, the effect of the force of gravity on the trajectory and, wind and weather conditions.

Application: In a public park, a man was shot in the chest. The park was crowded and multiple witnesses heard the gunshot but did not see the shooter. To reconstruct the crime scene, the following was done:

- (a) Bullet trajectory: The ballistics expert analysed the wound and determined the angle of entry of the bullet in his chest. Measured the height at which it hit the man. And using the formula for the trajectory of motion of the projectile, $s = u_o \sin \theta \times t - \frac{1}{2}gt^2$, the angle of elevation at which the bullet was fired was calculated.

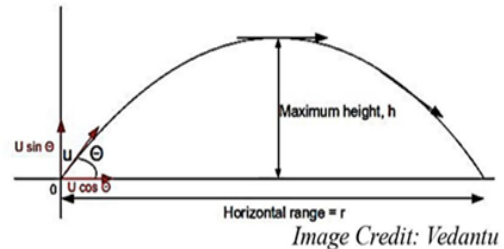

- (b) Ballistics Pendulum to find out the muzzle velocity (v_o):

Ballistics Pendulum: It is a device used to measure the velocity of a projectile basis the law of conservation of momentum. When a projectile collides with a suspended mass (pendulum), the pendulum gains momentum, causing it to swing upward. By measuring the pendulum's height and knowing its mass, we can calculate the velocity of the projectile.

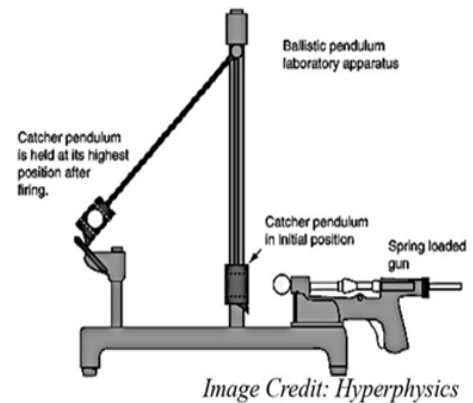

Before collision: If the mass of the bullet is M and the initial velocity v_o , the mass of the pendulum is m and is initially at rest.

Following the law of conservation of momentum, Momentum before collision = Momentum after collision.

$\Rightarrow M \times v_o = (M + m) \times v$, where v is the final velocity of the combined mass.

After collision: When the combined mass reaches its maximum height h , all the $K.E$ converts to $P.E$.

$$\Rightarrow \frac{1}{2}(M + m)v^2 = (M + m) \times g \times h \quad \therefore v^2 = 2gh \Rightarrow \sqrt{2gh}$$

$$\text{Now, } M \times v_o = (M + m) \times v \Rightarrow v_o = \frac{M + m}{M} \times \sqrt{2gh} \Rightarrow v_o = \frac{M + m}{M} \times \sqrt{2gh}$$

Refractometer and Refractive Index

Refractive Index is an optical property of a material that describes how much the light would bend if it passes through it. It is like a fingerprint! - no two materials can have the same refractive index, helping identify substances found at crime scenes. Investigators use a refractometer to measure the refractive index of the collected samples, comparing them to known values of refractive indices in the database. For example, it helps differentiate between red paint and blood found at the crime scene and identifies accelerants found at the crime scene.

The sample to be analysed is placed as a thin layer between the two prisms. A monochromatic light source, typically a sodium lamp is used to illuminate the sample. The light rays pass through one prism (illuminating prism with a rough base) into the sample. The light rays will then pass from the sample into the second prism. Some light rays would pass through it, bending at the interface, until the angle of incidence $>$ critical angle (i_c), when internal reflection takes place, not letting light travel into the prism, making that region dark.

This results in a sharp distinct boundary as seen through the eyepiece. The micrometer screw is adjusted for the crosshairs to align with the boundary, which gives the reading of the refractive index.

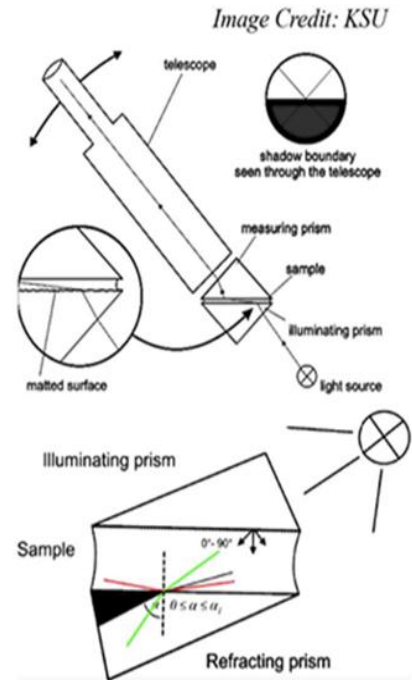
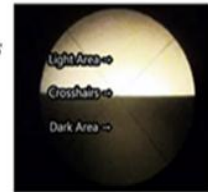
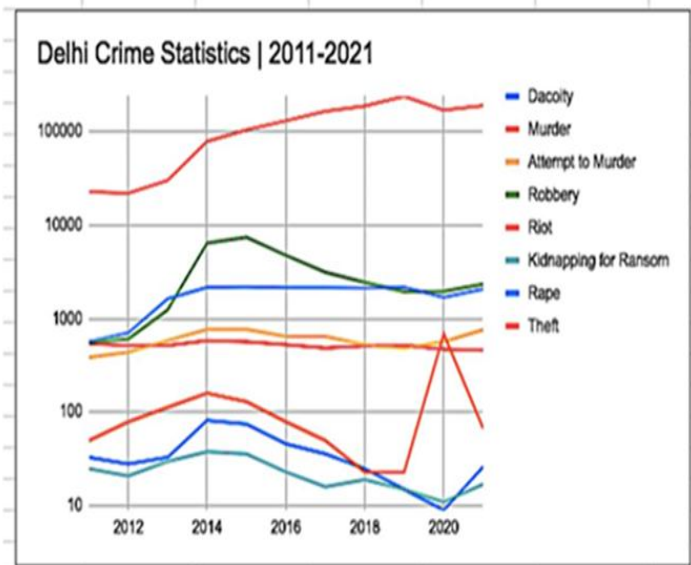

Image Credit: Random Experiments Int. (Youtube)



The above were just a few techniques incorporating knowledge of Physics to reconstruct crime scenes. The field of forensics is continuously evolving, with existing techniques undergoing modifications and new methodologies emerging due to advancements in research and crime scene forensics. The data publicly disclosed by the Delhi Police on their website shows that the total number of crimes reported in Delhi has increased from 2011 to 2022. The most common type of crime in Delhi is theft, followed by robbery and rape. The statistics also show that there was a significant increase in the number of crimes reported in Delhi in 2014, suspected to be due to urbanization and population density, the increase in poverty and inequality, the reduced police effectiveness and increased drug and alcohol abuse.



Line Graph made on Google Sheets based on the data available on the website of the Delhi police.

Conclusion: The integration of physics in forensic sciences has been pivotal in advancing crime investigations and presenting compelling evidence in the courts of law. As we confront the challenge of increasing crime rates in cities like Delhi, it becomes crucial to leverage the power of forensic physics to understand criminal behavior and uncover vital clues at the crime scene. By continuously adapting and innovating forensic techniques, researchers and law enforcement can respond effectively to changing landscape of criminal activities.

Referred Sources: Kennedy's Assassination Case Study, Neutron Activation Analysis, Digital Preservation of bullets, Tool Mark Analysis, Absorption and Emission Spectroscopy, Scanning Electron Microscope, SEM-EDX, Napoleon's Hair Analysis, Blood Spatter Analysis, Refractometer, Delhi Crime Rate Statistics.

PHYSICS IN FORENSIC SCIENCE

R. Venkatesh

Department of Physics, PSNA College of Engineering and Technology, Dindigul, Tamilnadu

Key words: UV, RUVIS, Fingerprint, Blue light, Electromagnetic spectrum.

Introduction

The use of ultraviolet and blue light technology has helped to solve countless crimes. Spectroline Ultraviolet (UV) and Blue Light inspection products are used by forensic and security professionals, crime laboratories, law enforcement officials, and others for a variety of criminal investigations and security applications. A wide range of inspection lamps, UV viewing cabinets, and safety equipment are available from the Spectroline, which was created specifically to meet the stringent requirements of crime-scene investigations, security requirements, and forensic laboratory work.

The light is a type of energy and electromagnetic fields produce electromagnetic radiation. Electromagnetic range comprises of gamma-beams, X-beams, bright beams (UV light), infrared beams, radio waves, and microwaves. In this article, let us find out about UV light exhaustively. The UV light has a frequency somewhere in the range of 10 and 400 nm that is more limited than the noticeable light yet longer than the X-beams and is a kind of electromagnetic radiation. These are available in daylight and contribute 10% of the complete light from the sun. Ultra violet radiation lies between noticeable light and X-beams along the electromagnetic range.

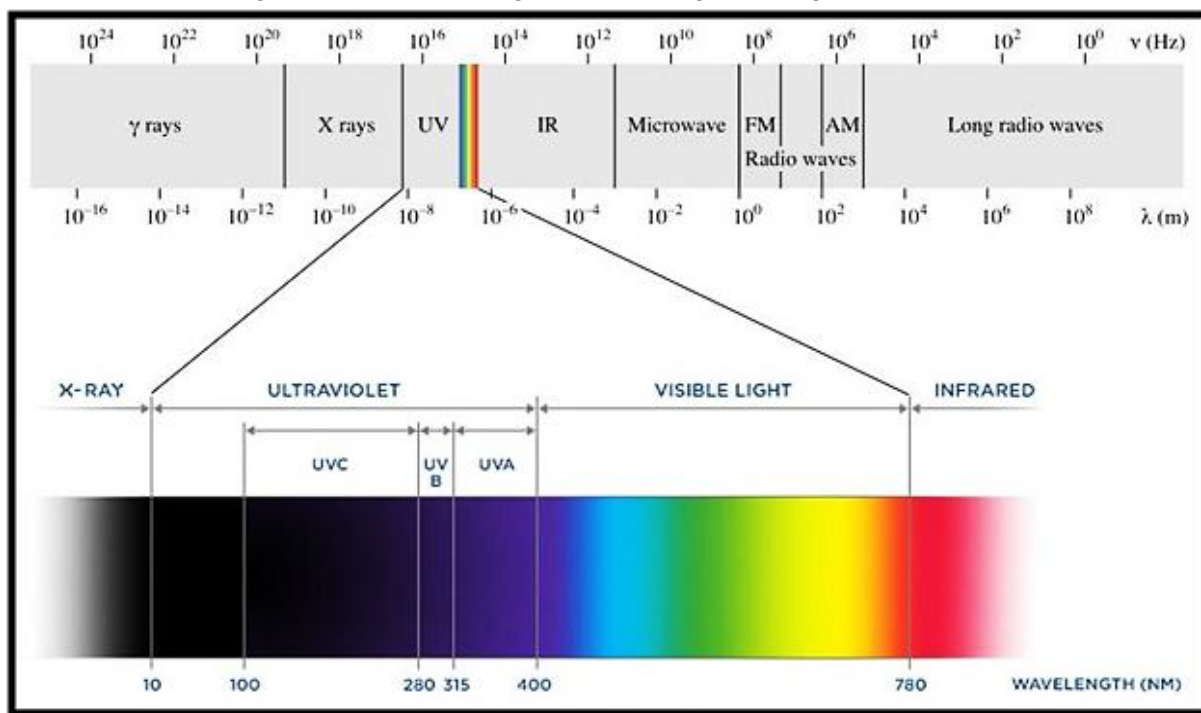

Fig. 1. The Ultra Violet region of Electro Magnetic Spectrum

The (Fig.1) shows the Bright (UV) light is electromagnetic radiation that has a frequency in the reach 10-400 nanometers (100 \AA to $4,000 \text{ \AA}$). It traverses the reach between the violet finish of the noticeable range and the X-beam locale. The bright range can be partitioned in various ways. The

close to bright (the long frequency end of the reach) stretches out from just past the violet finish of the noticeable range to around 300 nm (3,000 Å). The far bright stretches from 200 nm to the frequency of Lyman-alpha at 121.6 nm (1216 Å). Past this, from the frequency of Lyman-alpha to the beginning of the X-beam system at around 10 nm (100 Å), lies the super bright. Sun oriented UV that arrives at Earth's surface is sorted as UVA, UVB, and UVC. Much UV light from the Sun, including all super bright. Electromagnetic radiation is characterized as energy as waves that have both electrical and attractive properties. The electromagnetic range covers a consistent scope of frequencies. The energy of electromagnetic radiation relies upon the frequency of the radiation. The more limited the frequency, the higher the energy related with that radiation.

The scope of the electromagnetic range (Fig.2) and the purposes to which the radiation is put. At the most noteworthy energy (briefest frequency) are gamma beams which are delivered during some atomic radioactive rot processes (remembering atomic splitting for atomic weapons). Gamma beams are profoundly horrendous to life and enter generally matter. At the least energy in the range are radio waves which are utilized to communicate radio and TV signals across enormous distances.

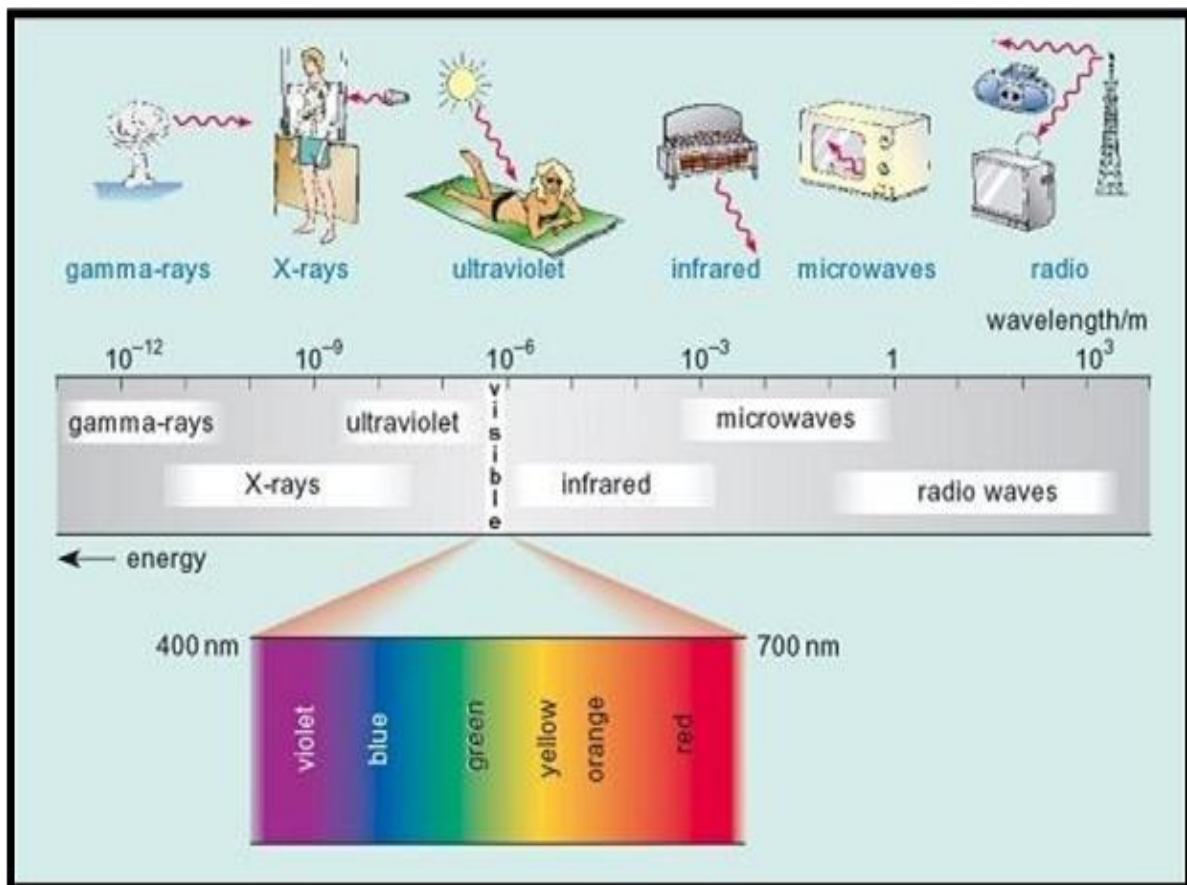

Fig. 2. The Electromagnetic Spectrum

Discovery of Ultraviolet Rays

It is a fascinating story UV rays were discovered. Johann Ritter sought to investigate whether there were waves that extended beyond the range of light that could be seen in the 1800s. At the time, it was recognized that blue light caused photographic film to become black more quickly than red light. Ritter exposed this film to more violet than usual, which is turned out as planned. This demonstrated that UV rays exist. Germs can be killed by the UV radiation that UV lamps release. They are

employed in the medical industry to sterilize surgical equipment. Additionally, the pharmaceutical business and the treatment of water both use UV rays.

Health-related effects of UV

The ultraviolet (primarily UVA) that arrives at Earth's surface causes tanning and the creation of vitamin D in the skin. It can likewise make unsafe impacts, like sun related burn and skin malignant growth. This type of light is created by tanning beds and stalls to deliver a suntan. Tanning beds are intended to produce just UVA beams; in any case, practically speaking they additionally emanate some UVB, which is bound to causing consuming and skin malignant growth. The UV light is additionally created by welding lights, carbon circular segment lights, and a few lasers. Unique insurances, like the utilization of goggles, ought to continuously be taken while utilizing such hardware. UV light is once in a while utilized in phototherapy to treat skin problems like dermatitis, psoriasis, and jaundice in infants.

Types of UV light

UV light or UV beam is grouped into three parts: bright A (UVA), bright B (UVB), and bright C (UVC).

Following is the table making sense of the qualities of these parts:

Ultraviolet A (UVA):

- ✓ The vast majority of the UV (98.7%) that contacts us on the world's surface is of type UVA and is impacted by the ozone.
- ✓ Blurring of paints and colors.
- ✓ UVA causes early maturing of the skin.
- ✓ UVA causes skin malignant growth called melanoma.

Ultraviolet B (UVB):

- ✓ 1.3% of the UV arrives at the world's surface and is exceptionally impacted by ozone.
- ✓ These beams are liable for burn from the sun and tan.
- ✓ For the creation of vitamin D, 270-300 nm frequencies are animated.

Ultraviolet C (UVC):

- ✓ UVC beams don't arrive at the world's surface as the vast majority of them are consumed by the climatic nitrogen, oxygen, and ozone, and the rest are dispersed.
- ✓ UVC causes injuries on the skin.

Other UV sources

Various sources have been concocted for delivering UV radiation. As indicated by the Health Physics Society, "Fake sources consolidate tanning corners, dim lights, easing lights, germicidal lights, mercury smolder lights, glowing lights, shone energy discharge lights, fluorescent and brilliant sources, and a couple of sorts of lasers". One of the most widely recognized approaches to delivering UV light is passing an electric flow through disintegrated mercury or another gas. This kind of light is regularly utilized in tanning corners and for sanitizing surfaces. The lights are additionally utilized in dark lights that make fluorescent paints and colors shine. Light-discharging diodes (LEDs), lasers and curve lights are additionally accessible as UV sources with different frequencies for modern, clinical and research applications.

UV Light in Forensics

Forensic specialists and scientists use various light sources to look at the proof found at a crime location. Among a plenty of light sources, Bright (UV) light, specifically, has gained notoriety for

proficient and successful assessment of naturally debased proof. Truly, the Government Agency of Examination (FBI) suggests that each piece of proof be dissected utilizing UV light. There are large numbers of benefits that make UV light great for review of basic proof. Maybe the most significant, however, is its property of watching out for the proof. The UV light does not harm or debase the proof. Additionally, the utilization of UV light brings to the front basic bits of proof that could never have been identified with the independent eye. It is particularly commended for showing minute subtleties of all signs, which helps with distinguishing basic snippets of data. Moreover, many things can be identified utilizing UV light, including all body liquids (e.g., blood, semen, spit, or vaginal liquids), wounds, fingerprints, marks, opiates, works of art, and ink stains.

Understanding UV Light

Ultraviolet light is a type of energy created by both normal and counterfeit sources. It is recognized by its frequency, which stretches out from around 180 nm to 400 nm.

- ✓ 180 nm to 280 nm is the short frequency regularly utilized in chromatography, mineralogy, and sanitization.
- ✓ 280 nm to 320 nm is the medium frequency and is sent through a quartz focal point. It is utilized for restorative and corrective purposes.
- ✓ 320 nm to 400 nm is the long frequency and is created by convenient lights. This frequency, specifically, is immensely advantageous to the legal business.

Standard Methods of UV Imaging

UV imaging is arranged into two sorts: intelligent and fluorescent. In intelligent UV imaging, the concerned area of proof is enlightened with UV light, and the reflected picture is shot. The focal point of the camera that catches the picture is fitted with an UV band pass channel a latent optical gadget that hinders any remaining wellsprings of light getting back to the film. In the fluorescent UV imaging, however, the camera is furnished with an alternate channel to obstruct all UV beams returning to the camera. Accordingly, just the noticeable light tones are caught in the film.

Crime

A few types of abnormality are serious infringement of our mores. They are viewed as serious enough breaks of social standards and values to be named wrongdoings. Wrongdoings are acts characterized as so inadmissible they are precluded by a code of regulations. A few sociologists center their inclinations explicitly around issues including criminal way of behaving. These sociologists or other social researchers who concentrate on the law enforcement framework, criminal regulation, and social request are called crime analysts. Wrongdoing is one of the classifications of aberrance it is characterized as "Crime is the infringement of standards that are composed into regulation." Or Crime is a way of behaving that disregard criminal regulation and is culpable with fines, prison terms, and different approvals.

Types of Crime

There are various kinds of crime which can be summed up as:

- ✓ Crime against person
- ✓ Crime against property
- ✓ Victimless crimes
- ✓ White-collar crimes
- ✓ Organized crime

- ✓ Corporate crime
- ✓ Hate crime
- ✓ Street crime

Crime against person

Violations against the individual, likewise called fierce wrongdoing. Macionis characterizes it as: "Violations that direct viciousness or the danger of savagery against others."

Example: burglary, murder, assault and so on.

Crime against property

Crimes against property, additionally called local misdemeanors. Macionis characterizes it as: "Crimes that includes robbery of property having a place with others."

Example: Vandalism related misdemeanors incorporate thievery, auto burglary, pyro-crime, land snatching.

Victimless Crime

A third class of offenses, excluded from significant wrongdoing lists, is harmless violations. Macionis characterizes it as: "infringement of regulation in which there are no undeniable casualties." It is additionally called violations without grumbling.

Example: self-destruction, prostitution, unlawful medication use, betting.

White-Collar Crime

There was a misguided judgment that individuals who perpetrate wrongdoing are poor. Edwin Sutherland tested this insight by introducing the idea of middle-class crimes which can be characterized as: "Violations committed by the people who have high economic wellbeing for the most part over their calling."

Organized Crime

Macionis characterizes coordinated wrongdoing as "A business providing unlawful great or administrations" Illustration of coordinated wrongdoing in Pakistan can be coercion, land snatching, and wood mafia.

Corporate Crime

Corporate crimes can be characterized as infringement of regulation done by an enterprise or individuals Who addresses that organization.

Example: Ecological contamination and selling Imperfect items.

Hate Crime

Crimes carried out against an individual, his property or a whole class based on any inclination.

Example: Partisan and ethnic crimes in Pakistan.

Street Crime

Any lawbreaker act or unlawful activity that is performed at a public spot is known as street crime.

Example: grabbing, battering and badgering.

Latent Fingerprint Detection

The utilization of fingerprints in the distinguishing proof of lawbreakers is the most often applied procedure in legal science. As the fundamental strategy for laying out character from follows left at crime locations, unique mark matching is as of now introduced in court in the UK multiple times more frequently than is DNA coordinating. It will discover that finger impression proof is typically

exceptionally sound and is one of the most solid types of ID; however there are difficulties to its utilization and human blunders can be made. Notwithstanding, these issues and mistakes in all actuality do should be placed with regards to the exceptional history of outcome in involving fingerprints in individualization.

Maybe the earliest recorded instances of what could today be referred to as the heralds of measurable science showed up in old China and Assyria. Millennia prior the Chinese and Assyrian individuals utilized fingerprints to lay out the personality of earth relics, and later on records, by naming them with an exceptional and recognizable imprint - the finger (or thumb) print.

The Chinese additionally utilized thumbprints on authoritative records and on criminal admissions. To the extent that is realized this was a straightforward and casual grouping of the fingerprints, rather like a mark. In any case, it may be the main indication of acknowledgment that an individual's fingerprints are exceptional to that individual - something actually viewed as evident today and structures one of the ground works of individual ID. The most common way of 'matching' people and things to a crime location that developed from unique finger impression examination is as yet the premise of quite a bit of criminological science.



Fig. 3. Reflected Ultra Violet Imaging System (RUVIS) Device

Frameworks for the grouping of fingerprints had been created during the nineteenth century by a few specialists. The disclosure that most fingerprints were imperceptible to the unaided eye yet could be made apparent by the utilization of powders was likewise evolved during the nineteenth hundred years. Identify idle fingerprints without the utilization of powders or synthetic substances by utilizing Reflected Ultra Violet Imaging System (RUVIS) at the scene or in the lab (Fig.3). RUVIS is best on smooth, non- penetrable surfaces and on multi-toned surfaces like magazine covers.

A loop is that sort of unique finger impression design in which at least one of the edges enter on one or the other side of the impression, recurve, contact or pass a fanciful line attracted from the delta deeply, and end or will generally end on or toward similar side of the impression from whence such edge or edges entered. Circles are the most well-known sort of unique finger impression, representing around 60% to 70% of all prints. They are described by a roundabout or oval-molded design. The prints recurve to frame a circle shape (Fig.4).

The essential utilization of a Scientific Light Source is for improving the identification of inert fingerprints. The utilization of fluorescent upgrade processes that praise a light source significantly builds the sorts of surfaces from which an idle finger impression can be distinguished. Consider the troubles of tidying and taking a print off of the accompanying surfaces: slim plastic sacks, inflexible pipe tape, dainty aluminum foil, intensely grained wood, substantial wall, block, printed polished magazine pages, paper items, and so forth. Utilizing conventional strategies, finger impression proof on these and different kinds of surfaces might go undetected or even excused on the grounds that they couldn't be recognized with sufficient detail.

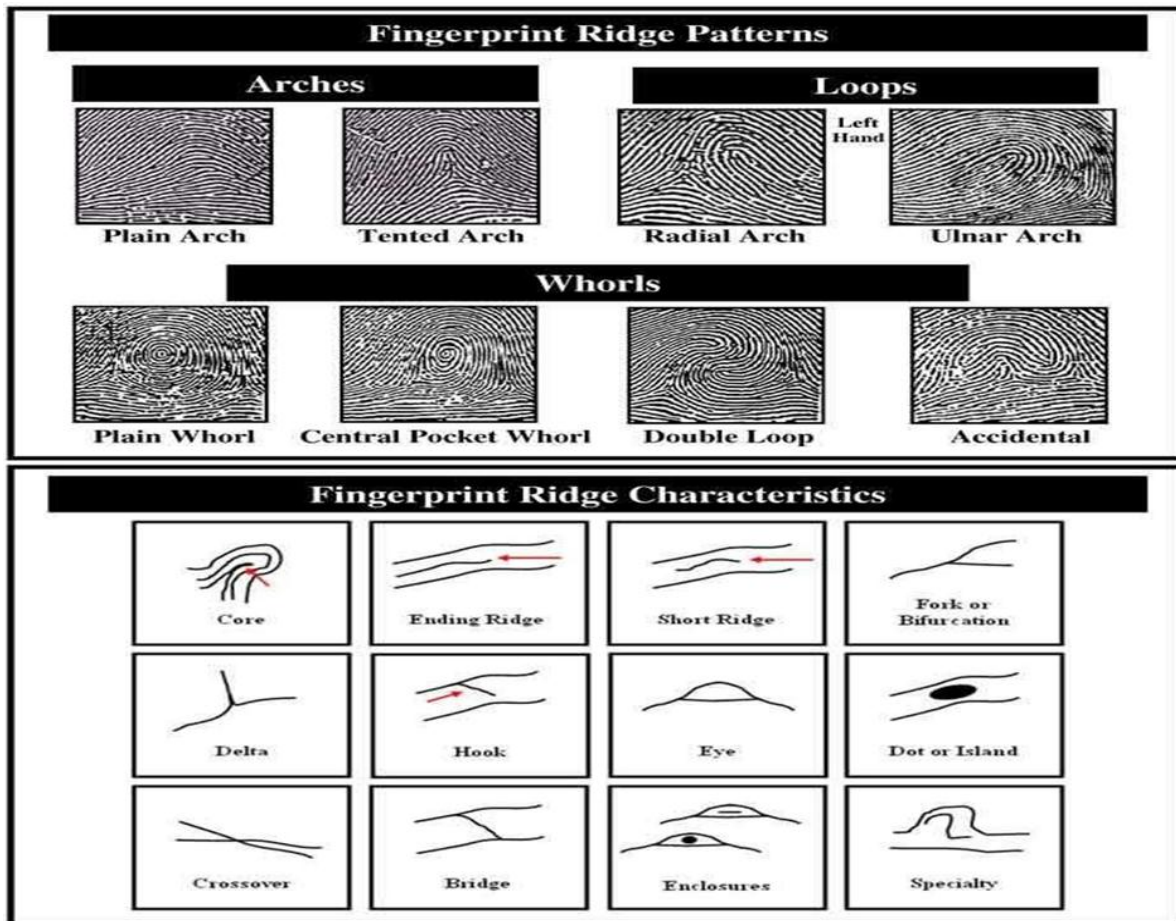

Fig. 4. Fingerprint Ridge Patterns and Characteristics

Measurable Light Source procedures have been effectively used for uncovering inactive prints on these and numerous different sorts of finished surfaces, foundations which veil edge detail, delicate surfaces, and tainted surfaces. Various frequencies are expected for handling various kinds of surfaces making a Measurable Light Source with tunable or different frequencies a sought-after instrument for any detective. Generally speaking, the foundation surface will likewise gleam under light source enlightenment. In these cases, it is important to tune to a frequency of light that makes the print gleam and not the foundation. RUVIS Gadgets permit the location of inert prints, preceding treatment. This is conceivable on surfaces that mirror light well overall and don't retain prints.

As surfaces become harsher or more permeable, "supergluing" the print might broaden the scope of surfaces on which RUVIS will work. Moreover, RUVIS might assist with trying not to over rage since Scene Extension RUVIS Gadgets can see the edges after just a slight smoldering. All RUVIS gadgets utilize 254 nm UV light however they are not distinguishing fluorescence. All things considered, the gadget searches for the reflections and dissipate of the 254nm light off of the unique finger impression edges. By changing the point of rate (Fig.5), the heading the light falls onto the surface, it endeavors to find a point that causes just the reflection and disperse of the unique mark edges to show up and the reflection off the foundation to vanish. Preferably, this outcomes in a picture where the edges show up splendid and the foundation seems dim.



Oblique Lighting

Perpendicular Lighting

Visible Lighting

Fig. 5. Appearance of finger print with light directions

This permits prevalent Foundation Dismissal as the gadget does not see inks and examples in printed material. However long the surface does not show rises or indents, the foundation will vanish. In opposition to prevalent thinking, RUVIS does not save time at the crime location. While it can show whether a print has detail, on the legitimate surfaces, the RUVIS will really recognize numerous incomplete or smeared prints. RUVIS does not abbreviate the time at the crime location; it assists with tracking down more proof than previously. The primary RUVIS gadgets used picture intensifiers to see the extremely frail 254 nm shortwave light. While they worked effectively at identifying the pictures, they were not great for catching the pictures. The intensifiers restricted the goal of caught pictures to basically "video" goal or 480 lines. No matter what the nature of camera joined to the rear of the unit, the picture intensifier was the restricting element. The new Computerized RUVIS frameworks hold the entirety of the low light level location and accommodates Super High goal, the Scene Extension UHD gives 4K goal.

Advances in Forensic Technologies

Carbon Dot Powders

Fingerprints are fundamental for breaking down numerous crime locations. Be that as it may, there are many reasons like might be difficult to see one obviously, including low responsiveness, low differentiation, or high poisonousness. Scientists have fostered a fluorescent carbon dab powder that can be applied to fingerprints, making them fluorescent under UV light and consequently a lot more straightforward to dissect. With this new technology, fingerprints will sparkle red, yellow, or orange.

Artificial Intelligence

While artificial intelligence (AI) has been utilized in numerous different fields for a really long time, it is somewhat new to measurable science. This is fundamentally on the grounds that all proof and the examination should stand up in court. Be that as it may, late progressions have seen man-made intelligence used effectively in all criminological parts of a crook case. While man-made intelligence is most frequently utilized in computerized criminology, it is progressively used to break down a crime location, look at unique mark information, make determinations from photo examinations, and that's just the beginning.

Nanotechnology

Nuclear and atomic innovation are tracking down their direction into measurable science. Dissecting scientific materials as of now level can offer researchers bits of knowledge that beforehand weren't available. Nano sensors are being used to inspect the presence of unlawful medications, unstable materials, and natural specialists on the sub-atomic level. Explicit progressions this previous year have incorporated researchers' capacity to dissect the presence of carbon and polymer-based nanomaterials to make their conclusions and help specialists.

Biosensors for Fingerprint Analysis

Like DNA, fingerprints found at a crime location can be matched to a suspect by looking at them. Be that as it may, fingerprints aren't clear or coherent all of the time. Measurable researchers can now utilize biosensors to examine the moment hints of natural liquids tracked down in fingerprints to distinguish the suspect. Information that can be identified incorporate age, meds, orientation, and way of life. Biosensors can likewise be utilized on other natural liquids found at a crime location.

Blockchain-Based Solutions Cloud Forensics

40% of individual and corporate information is presently put away in the cloud, on far off servers. Thus, computerized measurable researchers have needed to foster techniques for gathering, examining, and assessing information gathered from the cloud. Dealing with this information presents a few security and protection issues. To assist with safeguarding the respectability of the information's honesty and keep a guardianship chain, computerized scientific researchers have started to utilize blockchain innovation, as it is for all intents and purposes difficult to alter.

3D Technology to Determine Physical Fit

Measurable researchers frequently get actual proof that should be sorted back out. This is called actual fit and is a very much perceived technique for establishing that two pieces are from a similar source. This proof can be various materials, and frequently they can be somewhat delicate like bones. A new report at the College of Portsmouth utilized 3D imaging to plan the specific elements of a few consumed bones and afterward duplicated the pieces utilizing a 3D printer. This empowered them to decide whether pieces fit together or not without having to deal with the delicate proof unreasonably.

Drone Forensics

As of August 2021, there were 880,000 robots enlisted with the FAA in the US. More than 40% of those robots are enrolled for business use. The expanded fame of these automated flying vehicles has given hoodlums another apparatus to sneak medications, perform unlawful reconnaissance, and assault casualties. Scientific researchers are creating strategies and models for social occasion and examining information from drones, SD cards, and mobile phones.

3D Forensic Facial Reconstruction

Albeit this scientific innovation isn't thought of as the most solid, it is certainly one of the most fascinating accessible to measurable pathologists, legal anthropologists, and criminological researchers. In this method, 3D facial recreation programming takes genuine human remaining parts and extrapolates a potential actual appearance.

Conclusion

The demonstration of utilizing finger impression proof though a preliminary is an important measure, since it is dependable and working. Albeit the chance of committing an error in this strategy exists, its viability is affirmed by various uncovered violations and captured hoodlums during many years of its utilization. The uniqueness of fingerprints joined no sweat with which they are left on a surface when contacted makes them a significant guide to those trying to tackle wrongdoings. Fingerprints are generally simple to find at crime locations and inert prints might be pictured utilizing a legitimate succession of tests, some synthetic and some physical. The synthetic tests incorporate oxidation and decrease responses, called redox responses, and corrosive base responses. The actual techniques for imagining inactive fingerprints incorporate fluorescence of pollutants actuated by brightening with extreme focus light or lasers, and the utilization of powders that stick to lube or soil present on the print. As a rule, unique finger impression use in recognizable proof is truly solid, albeit each endeavor should be made to eliminate or limit blunders. Recreation of crime location is an essential utilization of Physical science. Many events like self-destruction or man slaughter, fall of a body from level, shot movement of a gun, glass entrance of rapid stone; projectile or device case broke down may be examined by utilizing the physical science.

PHYSICS IN FORENSIC SCIENCE

Sonika Jindal

DAV Public School, BRS Nagar, Ludhiana, Punjab

Key words: Refractometry, STEM, MERMER, Tomography, Spectroscopy.

Abstract: “There is no den in the wide world to hide a rogue. Commit a crime and the earth is made of glass” The principles of physics have validated the words of R W Emerson. Centuries ago, Archimedes solved the case of gold crown in which some silver had been mixed by the dishonest goldsmith, and found a method to determine the volume and density of irregular objects without damaging them. Archimedes principle of flotation explains why a dead body floats over water. Casper’s dictum-“a body decomposes in the air twice as rapidly as submerged in water and eight times rapidly as buried in Earth” is in tune with the Forensic Principle of Progressive Change and this makes a coroner’s job even more difficult. Locard’s Exchange principle- “Every contact leaves a trace” comes to the rescue. Principle of Analysis, Principle of Comparison and other laws- Law of Probability, Law of Individuality, Law of Circumstantial evidence further concretize the forensic strategies. The fictional detective Sherlock Holmes, rightly said, “What’s the point of being clever if you can’t prove it?” Uncertainty is a constitutive part of forensic science yet, every crime is provable. The seamless merger of Physics, Chemistry, Biology and Mathematics corroborates the probabilistic reasoning of Forensic science conclusively and convincingly.

Rightly said “It is better to let the crime of a guilty person go unpunished than to condemn the innocent”. Need for Corpus Delicti (Positive proof of the crime before conviction) led to a paradigm shift in Forensic technologies to solve crimes. Described below are some Modern Microscopic, spectroscopic, imaging techniques based on Examination of density, Refractive index, resistivity, elasticity, temperature and luminescence to unravel truth and dispense justice.

1. **Stereo zoom microscope:** This optical (dissecting) microscope enables 3-D visualization of low magnification (5X to 50X) by using light reflected from the surface of the object rather than that transmitted through it. Two separate optical paths with two objectives and eyepieces offer slightly different viewing angles to the right and left eyes. A long working distance (space between the specimen and objective lens), upright non-reversed image and large field of view make it a perfect choice for preliminary examination of evidence.

Comparison microscope consists of two microscopes linked by an optical bridge that helps to view two objects concurrently with the same grade of magnification. Invented by Calvin Goddard, Father of Ballistics, it is mainly used in forensic ballistics for comparing bullets, Lands and grooves, ejected and extractor marks, bullet striations, Indentation in cartridge cases, firing pin marks etc. A series of lenses and a mirror in the optical bridge brings the two images back together at a single eyepiece. The forensic examination of cartridges revealed the usage of AK47 rifle, 0.30 bore pistols and 9mm pistols in singer Sidhu Moosewala’s killing (2022).

Fluorescent microscope use fluorescence and phosphorescence instead of scattering /reflection /absorption. The Proton absorbs energy at one wavelength and release at higher wavelengths called Stoke shift. The specimen is labeled with fluorophores, is excited by UV light from a Xenon or mercury arc discharge lamp. An excitation filter allows only one wavelength to reach the specimen. Fluorophores emit fluorescence which is collected by the objective lens and sent to

the dichroic mirror and a barrier filter that eliminates the wavelength other than fluorescent sending it to eye piece to form the image.

In **Phase contrast microscopy**, phase shifts are converted into changes in amplitude which are observed as differences in image contrast. The annular ring present between the condenser and light source and the phase ring present between objective lens and image plane allow partial light to pass through it and this creates a contrast.

2. **Electron microscopy** uses a beam of accelerated electrons as the source of illumination and produces high resolution images. Magnetic coils acting as lenses focus the electron beam on the sample to illuminate it.

Scanning Electron Microscope SEM provides a 3 D image by detecting reflected or knocked off secondary electrons from the surface of a thick sample and has a resolution of 0.4 nm and maximum magnification of 2×10^6 times. This enables bit by bit observation of topography of specimen surfaces, analysis of Gunshot residues (GSR) left on the hands/ clothes of a shooter, investigation of Gemstones/ jewellery, Firearms identification. In electrocution death, current marks on the skin are observed by lung SEM and metallization (impregnation of metal ions in skin) is observed by variable pressure SEM (VP-SEM). The endogenous burns (Joule burns) in low voltage electrical injuries follow Joule effect $Q = I^2 \times R \times t$, where R is resistance (ohms), t is time (seconds), I is current (amperes) and Q is heat (Joules). Dry calloused and uncalloused skin, moist skin and thin skin have a resistance of 106, 105, 103, 102 ohms respectively.

Transmission Electron Microscope (TEM) uses transmitted electrons to create a 2D image of a thin slice of specimen on a fluorescent screen with the resolution of 0.5 angstrom and maximum magnification of 50 million times. It enables to see the internal composition of the sample as a whole.

In **Scanning Transmission Electron Microscope (STEM)**, Electron beam focused to a fine spot (0.05 -0.2 nm) is then scanned over the sample.

Reflection Electron Microscope (REM) detects the reflected beam of elastically scattered electrons and enables surface study of sample.

Scanning Tunnelling Microscope (STM) based on quantum tunnelling images surfaces at the atomic level. A bias voltage applied between the sample and an extremely conductive tip allows the electrons to tunnel through the separating vacuum. The tunnelling probability of the electron and the resulting tunnelling current is a function of distance between tip and sample, applied voltage and the local density of the states (LDOS) of the sample. The voltage applied to the piezoelectric tube attached to the tip maintains a constant distance between the tip and sample surface. Changes in this voltage allow a 3D picture of the material surface as the tip is scanned back and forth across the sample.

Atomic Force Microscopy (AFM) generates images by scanning a small cantilever (made of silicon nitride) over the surface of a sample. Forces (Vander-Waal forces, capillary forces, electrostatic forces, chemical bonding) between the tip and the sample lead to a deflection of the cantilever according to Hooke's law. The short tip on the end of the cantilever contacts the surface, bending the cantilever and changing the amount of laser light reflected into the photo diode. The height of the cantilever is adjusted to restore the response signal, resulting in measured cantilever height tracing the surface. Applications include Analysis of textile fibers, hair and pressure sensitive adhesives, examination of ink crossings in document to determine the sequence of pen strokes thus helping in authentication. The morphological changes of the blood cell are analysed to estimate the time elapsed after death. Age of the blood spot can be determined from

the dried blood stain by analysing the changes in the elasticity of erythrocytes in a nanoscale. Carbon nanotubes help to analyse DNA sequences using this technique.

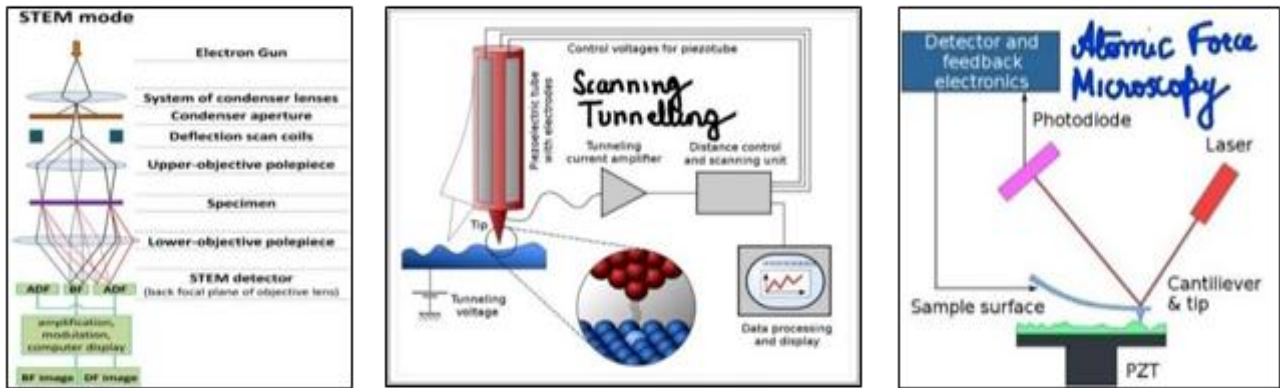

3. Energy dispersive Micro X ray fluorescence (MXRF): This nondestructive technique revealing the elemental composition of materials, is based on the emission of characteristic secondary or fluorescent X ray radiation when a sample is exposed to exciting radiation from more energetic X ray or Gamma Rays.

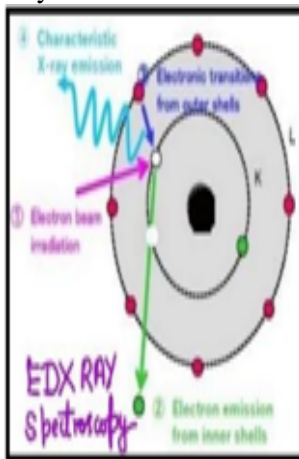

Exposure of energy greater than the ionization energy expels tightly held electrons from inner orbitals of the atom thus making the electronic structure unstable and allowing electrons in higher orbitals to fall into the lower orbital to fill the hole left behind. The energy of released photon equals the energy gap of the two orbitals involved. Absorption of radiation of a specific energy results in the re-emission of radiation of a different energy (generally lower), the phenomena is called fluorescence. The wavelength of this fluorescent radiation is calculated by Planck's law $E=hc/\lambda$. The Spectra are displayed as intensity versus energy or wavelength (called Wavelength dispersive analysis). It detects metallisation during electrocution when peaks of iron and zinc are indicated in spectrum and also for latent finger print analysis.

4. Nano forensics is associated with the development of Nano sensors, Nano chips and Nano manipulators for crime investigations like Nano scale detection of explosive gases, illicit drugs, biological agents and residues of inorganic pigment in hit and run accidents and also for establishing the authentication of tapes and identification of speakers thus solving cases related to cyber-crime and sting operations. Gold and silver Advanced Nano sensor devices like electronic nose, nanotubes and Nano mechanical devices detect bombs, grenades and illicit drugs.

5. Forensic imaging: In a CT (computed tomography)scan, the 2D cross sectional images (slices) of body parts taken by X rays are transformed into 3D images by a computer. Magnetic resonance imaging (MRI) is radiation free and is based on nuclear magnetic resonance (NMR) in which an NMR spectrum is obtained when a body placed in the magnetic field is irradiated with radio waves having a frequency equal to the precession frequency (Larmor frequency) of protons. The pulsed RF, excites the protons and spin them out of equilibrium transversely (T_2 relaxation). When the radio frequency field is turned off, the MRI sensors detect the EM energy released as the protons realign longitudinally with the magnetic field ($T1$ relaxation). $\omega_0 = \gamma B_0$ where γ is the gyromagnetic ratio, B_0 is the strength of magnetic field and ω_0 is Larmor frequency. The time it takes for the protons to realign with the magnetic field as well as the amount of energy released depends on the environment and chemical nature of the molecules. PMMRI (Post Mortem MRI) assists in injury assessment in

victims of violence (strangulation) and also for virtopsy (virtual autopsy). The 3D surface scanners reconstruct traffic accidents.

In Positron Emission Tomography (PET) scan, the positron emitted by the beta plus decay of radiopharmaceutical collides with an ordinary electron and the two particles annihilate and gamma rays are released. Gamma cameras detect gamma rays to form a 3D image.

Cone beam computed tomography (CBCT) is a non-invasive radiographic imaging technique that assesses dental age by allowing accurate 3D imaging of hard tissues. Software programs incorporating sophisticated algorithms generate a 3D volumetric data set that provides primary reconstruction images in all three orthogonal planes (axial, sagittal and coronal) Dental modules of the accused matched with bite marks on the victim's body in horrendous Nirbhaya gang rape case- was proved by **Forensic Odontology**.

Radiomics is the examination of charred bones in cases of accidental industrial fires, arson, burnt corpses, vehicle fires etc. Heat exposure causes pyrolysis of compounds causing shrinking, distortion and fragmentation of bones. CT, MRI, PET, radiographs and ultrasound extracts Radiomics feature information from images using data characterization algorithms. **Palatal Rugoscopy** (study of palatal rugae) and Cheiloscopy (study of lip prints) also make identification clear.

6. Neutron activation analysis: Discovered in 1936 by Hevesy, NAA is a sensitive non-destructive Multi-elemental technique that involves bombarding the sample carrying rare earth elements with neutrons to create radio nucleides, that further undergo β and γ decay to achieve stability. Bombardment with gamma radiation occurs in photon activation analysis. Measuring the specific induced radiation i.e., decay rate, decay constant and $t_{0.5}$ helps to identify elements both quantitatively and qualitatively. This is effective for bulk detection of paints, hair, nails, glass, elements like antimony and barium in Gun Shot Residues. No/minimal sample preparation is required.

7. Raman spectroscopy: Based on Scattering of light, this technique studies vibrational (Sometimes rotational and other low frequency modes) mode of molecules and thus create a structural fingerprint of molecules. It relies on inelastic scattering of photons (0.0001%) called Raman scattering. A nondestructive technique capable of being used in aqueous solution of the sample, this technique can detect explosives from a safe distance.

The **Surface Enhanced Raman Spectroscopy SERS** detects trace elements in soil, illicit drugs, dyes, paints, fibres, textiles, lipsticks and smears of shoe polish. Like springs, the bonds in molecules vibrate in different directions at specific frequencies unique to the molecule and the type of bond. The interaction of electric vector of electromagnetic radiation and resulting induction of electric dipole moment causes the molecules to get periodically deformed (molecular polarization) resulting in their vibration at a specific frequency. When the incoming light has the same frequency as the molecular vibration frequency, light gets absorbed thus increasing the vibration and amplitude of emission. The interaction of laser (Visible, near IR or near UV) with molecular vibrations, results in the energy of the laser photons being shifted up (Anti Stokes) or down (Stokes). The frequency shift between the original monochromatic beam of light and the Raman scattered light called Raman shift gives information about the vibrational modes in the system. Only anisotropically polarizable non polar molecules are Raman active.

8. Mass spectrometry: Every compound has a unique mass fragmentation. Gaseous ions produced by bombarding the sample with a beam of electrons are characterized by their mass to charge ratios (m/e)

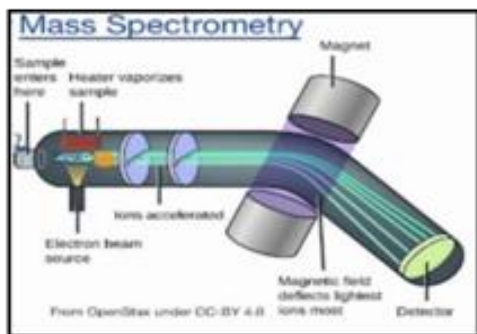

and relative abundance. Microscopic traces of crime evidence like clothing, carpet fibers, glass shards, paint flecks, pesticides, inks and dyes and metal pieces are identified. Other applications are drug testing and discovery, food contamination, pesticide residue analysis, protein identification, isotope ratio estimation and carbon dating. **Atomic absorption spectrophotometry (AAS)** is based on the principle of Beer Lambert law i.e. the absorbance \propto sample concentration and the length of the light path.

This spectro-analytical technique quantitatively determines over 70 different elements in a solution or directly in solid samples via electrothermal vaporization. AAS quantifies absorption of ground state atoms in the gaseous state. Solid sample insertion occurs by **Laser Ablation Inductively Coupled Plasma MS (LA-ICP-MS)** method in which a high density beam converts the sample into a sublimate which then reaches the atomizer using inert gas as aerosol carrier. Liquid samples are inserted by a nebulizer. The LA-ICP-MS machine breaks glass samples of any size down to their atomic structure which can be matched to a glass sample from a crime scene. It detects lead and mercury during heavy metal poisoning and in the gunshot residues.

Atomic Emission Spectroscopy (Flame Photometry) uses flame as a source of light and examines the wavelength of photons emitted by atoms and molecules during their transition from an excited state to a lower energy state. AES is reverse of AAS. Each element emits a characteristic set of discrete wavelengths according to its electronic structure. Elemental composition (Qualitative) is determined by observing these wavelengths. Emission of light \propto the number of atoms present hence enabling quantitative estimation. **Microwave spectroscopy** uses the microwaves and **Mossbauer spectroscopy** uses gamma rays to obtain the spectrum. Spectroscopy is direct viewing of a spectrum, Spectrometry is measurement of spectrum by an analyser and Spectrography is photographing a spectrum.

9. DNA Sequencing: This technique analyses old bones/teeth to determine the specific ordering of a person's DNA nucleobases and generate a "read" or a unique DNA pattern that identifies a criminal. Micro satellites are a set of short repeated DNA sequences at a particular locus on a chromosome which vary in number in different individuals and are used for genetic fingerprinting i.e. Extracting and identifying the base pair pattern in an individual's DNA. The decoding of DNA, called DNA profiling/typing generates trait possibilities. DNA phenotyping (Molecular photo fitting) combines genomics (DNA sequencing or genotyping) and computer to generate a sketch of a person from a single DNA specimen found from a crime scene. DNA profiling proved the accused guilty in the Nirbhaya Delhi Rape case (2012). Unlike DNA, a complete set of proteins produced by an organism, called **Proteome** found in blood and bones change over time thus helping coroners to find victim's age at death. High/low voltage electrophoresis and immuno-electrophoresis separates and analyses protein in blood.

10. Brain mapping: Brain fingerprinting (mapping) is a non-invasive, guilty knowledge test based on mapping of quantities or properties on to spatial representations of the brain resulting in maps. This Brain Electrical oscillation signature profiling (BEOSP) acts as a neuropsychological interrogation technique. A part of the wave that corresponds to a specific action is called Event Related Potential (ERP). A **MERMER** (Memory and encoding related multifaceted electroencephalographic response) is initiated in the accused when his brain recognizes relevant information pertaining to the crime. The positive component P300 (MERMER) is an ERP referring to a spike in brain activity at 300 ms in

response to a target stimulus which is alternated with standard stimuli to create an odd ball paradigm. Common tools for recording the electrophysical response are Electroencephalogram (EEG), Magneto encephalogram (MEG), PET and single photon emission computed tomography (SPECT). The test gave the police strong leads in the sensational Aarushi Talwar murder (2008) case.

The polygraph or lie detector measures subject's physiological indicators like blood pressure, pulse, muscle movement, sweat gland activity (Galvanic skin reflex), upper and lower breathing patterns, respiration and electrodermal response (skin conductivity) to identify truth, as these are different in a liar from what they would be otherwise. Parts of polygraph are: a) Pneumograph b) Galvanograph c) Cardiosphygmograph d) Kymograph. In the macabre Nithari serial murder case (2006), the accused duo were subjected to polygraph tests and brain mapping. The main suspect in the ghastly Shraddha Walker murder case (2022) underwent the test and admitted to the gruesome killing.

Narco analysis involves the use of psychoactive drugs like barbiturates (sodium pentothal/ Amytal or scopolamine) to generate a hypnotic state of stupor where imagination is neutralised. The sedative binds with the gamma aminobutyric acid GABA (inhibitory Neurotransmitter). Cardio cuffs and sensitive electrodes measure blood pressure/ pulse and change in sweat gland activity. Mumbai 26/11 terrorist Ajmal Kasab's confession in the Narco-analysis provided a tell-tale insight into the propaganda used by terror masterminds to brainwash poor men. No wonder, this analysis is called the rape of the mind of the accused.

11. Magnetic finger printing and Integrated Automated Fingerprint Identification System

(IAFIS): This biometrics system is most effective for criminal identification, enables computers to make rapid and accurate comparisons between fingerprints obtained from crime scene and those available in the police records or virtual database of recognized and unidentified prints. Incorporation of magnetic fingerprinting dust and no touch wand gives a perfect impression without contamination. Fluorescent carbon dot powder makes the fingerprints fluorescent under UV light. The analysis proved one of the convicts guilty in the Nirbhaya rape case. The latest Time Tracing fingerprint technology can find out the time frame when a fingerprint was left behind thereby helping to eliminate the innocent suspects who left the scene of crime long before crime was committed.

12. Computer based facial reconstruction recreates the face of an individual from its skeletal remains. Forensic anthropology analyses the skeletal remains of deceased individuals to figure out gender, stature, probable age at death, time and cause/manner of death. User input data like scanned photographs of the cranial remains and photographs of facial features enable forensic software to deduct the 3-D appearance. Superimpositions are created by superimposing a photograph of an individual, suspected of belonging to the unidentified skeletal remains over an X ray of the unidentified skull. If the skull and the photograph match, then the anatomical features of the face should align accurately.

13. IR spectroscopy: Used for the identification of pigments in paintings and manuscripts, determination of blood alcohol content of a suspected drunk driver, this nondestructive technique enables quantitative and qualitative analysis of samples by identifying covalent bonds and functional groups in a molecule. Complementary to Raman spectroscopy it depends on the change in the dipole moment of polar molecules. IR active molecules will be Raman inactive and vice versa. When the frequency of the IR passing through a sample is same as that of the vibrational frequency of a bond or collection of bonds absorption occurs. The Dispersive (Double beam) IR spectrometry uses a diffraction grating to obtain monochromatic beam of IR light which is directed to the sample and the

absorbance of that specific wavelength is detected. A change in the angle of diffraction grating enables examination of absorbances of all wavelengths of IR light to obtain an IR spectrum.

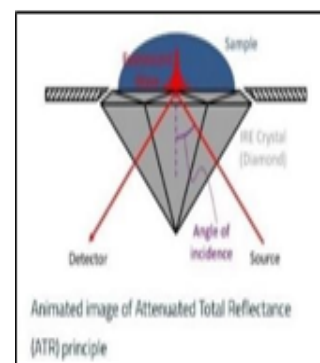
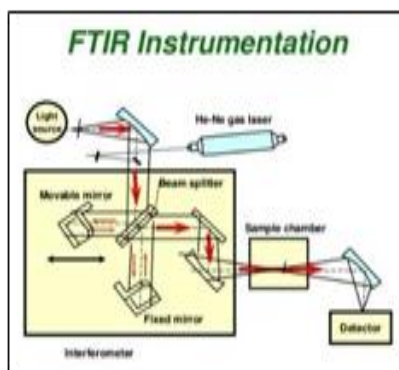
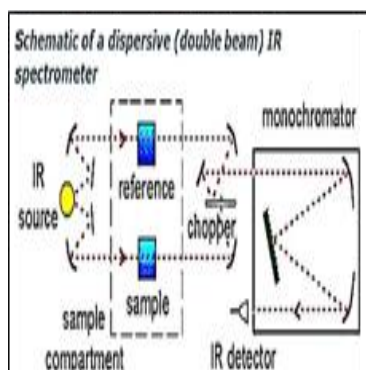

In a Fourier Transform IR Spectroscopy (FTIR), an interferometer like Michaelson interferometer splits the IR beam by a beam splitter and directs them to two mirrors which bounce the beams back so that they recombine. Changes in the position of a movable mirror cause the change in the phase difference between the beams that results in a different interference pattern. A mathematical function called Fourier transform processes the interferogram that converts the intensity versus time spectrum into intensity versus frequency spectrum. This rapid and inexpensive technique makes an accurate diagnosis of current mark during electrocution and characterization of subtle biochemical differences in the tissues in cases of Asphyxiation and sudden cardiac death.

In Attenuated Total Reflectance ATR-FTIR technique, a small reflecting prism or crystal is placed in very close contact with the sample material, which causes total internal reflection. A standing wave called Evanescent Wave, of a few microns height is generated on the opposite side of the boundary from the reflected light. Molecules in the sample absorb energy from the evanescent wave leading to an attenuation of the reflected beam below that is detected by the spectrometer.

14. UV spectroscopy is a type of absorption spectroscopy in which light of ultraviolet region (200 to 400 nm) or visible region (750 to 400 nm) absorbed by molecules results in the excitation of electrons from the ground state to higher energy state. Light emitted from Tungsten lamp (visible light source) or hydrogen-deuterium lamp (UV light source), after passing through a monochromator divides into two beams one of which passes through a reference cell and the other through the sample cell, both cells made up of silica or quartz. A pulsating or alternating current is produced in the two photo cells (detectors). the intensity of light coming from the reference cell being stronger. This low intensity AC is amplified to get a clear signal. Applications include the analysis of narcotics /drug testing and trace material analysis. This is used to analyze controlled drugs, misused drugs like cocaine, cannabinoids, anabolic steroids, fentanyl, detect poison specifically organophosphorus pesticides and also to examine involvement of drugs in incidence of murder sexual assault and assessment of alcohol level of blood.

15. Motic polarizing microscope: It offers qualitative and quantitative analysis of anisotropic

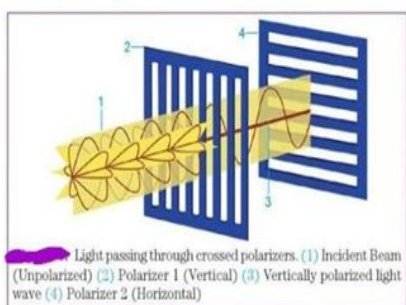

substances, detection of pleochroism, determination of refractive index and estimation of **birefringence** (double refraction) thus is an essential aid to identify minerals splits the incoming beam of polarized light into two orthogonal light rays (Ordinary and extraordinary ray) traveling at different velocities through the crystal and emerge out of phase and undergo interference. The ordinary wave remains fixed in one direction with the light passing straight through the crystal without interruption. The extraordinary wave circles the ordinary wave changing as it hits

different areas of the rotating crystal and refracts differently. This is because the polarization of the light changes as the object is reoriented. Uniaxial minerals have two principle refractive indices, exhibit two colors (dichroism) and are tetragonal/ trigonal/ hexagonal crystal systems while biaxial Substances having three principle refractive indices, exhibit three colors (trichroism) and belong to orthorhombic, monoclinic, triclinic crystal systems. The laying of carbon fiber in one direction instead of 4 axis weave pattern supposedly led to the catastrophic implosion of **Titan submersible** (June 2023) in the North Atlantic ocean, as the 5-inch thick aviation grade carbon fiber body could not bear the compressive radial stress from an exorbitant 5452 psi hydrostatic pressure at 3800 meter depth. Titanium/ tempered steel body could have been a better option. Ultrasonic testing could have detected the cracks in the carbon fibre anisotropic composites rolled along the circumference of the shell. **Adiabatic compression** led to rapid rise in internal energy and temperature as surrounding water did work on the system. $PV^\gamma = K$ where γ (specific heat ratio C_p/C_v) for air = 1.4 .It means $V_1/V_2 = (P_2/P_1)^{1/\gamma}$. Hydrostatic pressure increases with depth. Taking Final pressure $P_2 = 371$ atm and Initial pressure $P_1 = 1$ atm, we get $V_1/V_2 = (371)^{1/1.4} = 67$. Using combined gas law, $P_1V_1/T_1 = P_2V_2/T_2$, we get $T_2/T_1 = P_2V_2/P_1V_1 = 371/67 = 5.54$. Assuming initial temperature $T_1 = 293$ K, the final temperature T_2 due to adiabatic compression is calculated as 1623 K.

16. Refractometry: This is used for purity investigation of diamonds and forensic analysis of glass. Refractometers measure the refractive index from the observed refraction angle using Snell's law. $n_1 \sin \theta_1 = n_2 \sin \theta_2$ where θ_1 and θ_2 are Angle of incidence and Angle of refraction respectively of a ray crossing the interface between two media with refractive indices n_1 and n_2 . Based on the principle of total internal reflection, Abbe's refractometers measure refractive index of liquids, placed in the form of thin film between two prisms. This further allows the determination of concentration using 1) Lorentz lorenz equation, $\alpha = (3/4\pi N)[(n^2 - 1/n^2 + 2)]$ where α is the polarizability of the molecule, n is the refractive index of the substance and N is the number of molecules per unit volume and 2) Gladstone Dale relation $(n-1) = G\lambda\rho$, where G is the Gladstone Dale Constant, λ is the wavelength of light beam and ρ is the density of the fluid. Gemstone refractometer identifies gems like Ruby, Sapphire etc. as these are optically anisotropic and demonstrate birefringence.

17. Polarography: It is a form of voltammetry that uses paired electrodes -dropping and stationary to determine the identity and concentration of oxidizable or reducible substances. A current vs voltage graph is obtained by exposing the sample to a set range of voltages the Ilkovic equation relates the current to the concentration of the test material. $I_d = 607nD^{1/2} m^{2/3} t^{1/6} C$ where I_d is the Diffusion current in microamperes, 607 is the Numerical constant for various constants like Faraday's constant, density of mercury and geometry of mercury electrode. n is the number of Electrons involved, D is the diffusion coefficient in $\text{cm}^2\text{sec}^{-1}$, m is the mass of mercury introduced by capillary in mg/sec, t is the electrode drop time in seconds and C is the concentration in mmol/L.

18. Electrostatic Detection Apparatus (ESDA): This non-destructive technique deciphers indentations (impressions on paper) in cases of cheque forgery, ransom notes and extortion letters. It is based on surface charge effect created by paper to paper friction especially where a writing instrument is pressed down into the uppermost sheet of paper. The charge transport model explains the principle through Mylar-paper-platen structure where papers sandwiched between grounded platen and Mylar charging film act as a capacitor with a change in capacitance due to differing compression of paper. **Electrostatic Dust Fingerprint Lifter (EDFL)** uses high voltage electrostatic charges to lift dry dust fingerprints on to a charged black plastic film for better contrast and photography.

19. Alternative light Source(ALS) photography: The principle of ALS is fluorescence and it detects serological fluids, finger and palm prints on metals, bits of paint, fiber, hair, glass crystals etc. Since different organic materials will absorb light and fluoresce at different wavelengths so the color of the illuminating light is very critical to illicit the maximum fluorescence from the evidence while minimizing the background fluorescence, using a filter. Document forgery and any bruising below the surface of the skin are detected. **Reflected UV imaging system (RUVIS)** uses high intensity, shortwave (UV light 254 nm) to search, view and capture latent fingerprints from glossy surfaces like plastic bags, photographs and credit cards.

Infrared photography uses tungsten lamps/ quartz halogen lamps to photograph gunshot wound remnants, erased handwriting, burnt paper and serological fluids. In **Cross polarized photography** the light passes through two polarizing filters at 90° to each other. The portable high intensity **Poli light** made of a powerful light emitting diode lamp contains the UV, visible and IR components from which latent fingerprints and bodily fluids are identified. Drones incorporated with remotely piloted vehicles are (RPV), unmanned aerial systems (UAS), Light illumination Detection and Ranging (LiDAR) technology map the whole crime scene digitally. **LIDAR** is a remote sensing device that uses an infrared light pulsed laser to calculate the distance between two points. **Laser holography** produces sharp photographs eg. of a shoe print left by a criminal on the carpet. **Photogrammetry** gives an accurate 3D reconstruction of an accident or crime scene and is specially used for crush measurement on damaged vehicles, skid mark measurements, bullet trajectory determination, shoe and tyre print scanning, blood spatter measurement, accident and crime scene mapping and diagramming. **Video Spectral Comparator** is Computer-compatible and enables document examination by comparing and differentiating the inks by evaluating the infrared reflection and luminescence qualities inherent to the ink. With this, the investigators can see obscured or hidden writing, determine the paper quality and origin and “lift” indented writing. Use of visible, IR, UV, transmitted, coaxial and oblique lighting conditions or their combination allows observing and recording the observations of documents or inks on exposure to light of various wavelengths. It is used for the Visualization of hidden security features in documents like passports and driving licenses and revealing obliterations/alterations in cheques, official letters and authentication of banknotes, will, art works and valuable artifact. **High speed ballistic photography**, based on stroboscope enables coroners to identify and match bullet trajectories, analyse glass shatters, bullet holes, impact marks and Gunshot wounds. Based on persistence of vision, a strobe makes the cyclically moving object appear to be slow moving/ stationary by producing repetitive flashes of light.

Besides the techniques above, the following branches of forensic science also provide useful insights to a coroner.

20. Forensic Ballistics: “Every firearm tells a story”. Described by Newton’s laws of motion, conservation of energy and momentum, ballistics deal with the motion of projectiles and considers firearm as a thermodynamic machine in which the potential energy of gunpowder is transformed into

the kinetic energy of the bullet (projectile). The energy conversion efficiency of a fire arm depends on its construction, calibre(diameter of the bullet) and barrel length. The spiral grooves called rifling in the bore of a rifle spin the bullet and increase the rifle's range and accuracy. A bullet fired from rifle has more energy than that fired from shotgun (short range multiple projectiles with smooth bore). Blocking of gases within the barrel called "**Obturation**" makes the ammunition move forward effectively (**Internal ballistics**). A 6-chambered Smith and Wesson 0.455 calibre revolver with only 0.400 calibre ammunition fired by Udham Singh on March 13,1940 in Caxton Town Hall London killed only Michael O'Dwyer with two shots. Due to ineffective obturation, the other targets Zetland (2 shots), Lamington (1shot) and Dane (1 shot) escaped with minor injuries. Forensic ballistics involves examination of evidence from firearms used in a crime. The gun leaves microscopic marks called ballistic fingerprints, on the bullet and cartridge case as the bullet is fired. Five key identifiers of a firearm are its make, model ,calibre manufacturer and serial number. The Examination of individual and class characteristics of a spent bullet, spent cartridge or firing residues recovered from the scene classifies and traces the ammunition, establishes the bullet trajectory, identifies the shooting firearm and also identifies the shooter or establishes the location of a firearm. **Puppe rule** determines the sequence of multiple shots fired at the cranium and is applicable to glass fractures too. Radial fractures end when they cross paths with another existing fracture line. **Billiard ball ricochet effect** is excessive spreading of shot pellets due to passage through an intermediate target such as a glass window and this leads to inaccurate calculation of distance between the position of shot gun and the actual target (**External ballistics**). Besides comparison microscope, software programs like Integrated Ballistic Identification System (IBIS) and Integrated

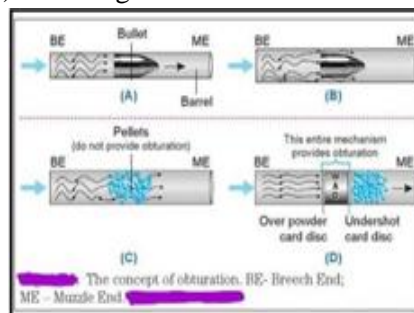
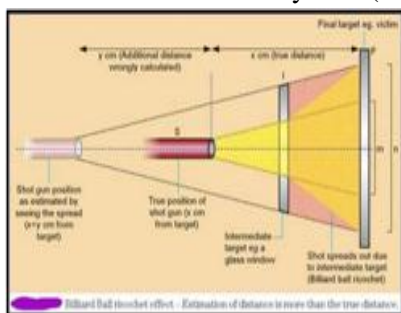

Ballistic Information Network (IBIN) are used for ballistic comparison. John F Kennedy was assassinated by a 6.5 mm calibre carcano (Italian bolt-action) military rifle. Every gunshot wound is

X rayed to collect bullets or fragments. Post-mortem computer tomography (Virtopsy) locates bullet fragments. Wound morphology (**Terminal ballistics**) tells the bullet calibre, shape and range of the firearm weapon. The range ie distance between muzzle and target is calculated by examining three effects produced by the bullet ie singeing of hair, tattooing in the dermis and blackening of epidermis by IR photography.

Forensic hair analysis: The sample of hair having root is analysed by Short Tandem Repeat (STR) but that without root is subjected to mitochondrial DNA testing of the hair shaft. A combination of DNA analysis and comparison microscopy determines the hair characteristics precisely.

Forensic glass analysis: Measurement of refractive index by immersion method involves immersing glass fragments in oils (of known refractive index) and examining the Becke lines. Density meter determines the density and elemental analysis is done by various microscopic and spectroscopic techniques. Analysis of glass fracture determines which side of the glass was force applied that resulted in its fracture. The **3R rule** determines the direction from which fracture was formed from. Radial fractures make Right angles to the Rear side of the glass pane. A projectile like a stone /bullet hitting a glass pane would produce radial and concentric fractures. A bullet leaves a cone fracture(bevelling) where the hole is narrower at the point of entry and widens towards the exit point. A

projectile hitting the glass at 90o angle leaves a symmetrical hole while that hitting at some other angle leaves an elliptical hole.

The **bone fractography** reveals extent of fragmentation, cracking pattern and thus offers crime scene reconstruction in blunt trauma injuries. The stress versus strain curve of bones gives the yield point at which bone fractures. The load (stress) i.e. force applied at the failure gives the tensile strength

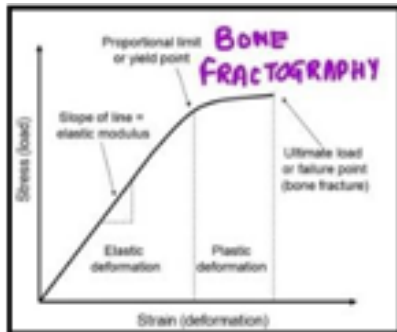

and the area under the curve is a measure of the toughness of the bone. Fractography not only analyses bones and broken glass but it can also determine whether a cause of a train derailment was a faulty rail, or if a wing of a plane had cracks before a crash. **Aviation forensics: Black box** in an aircraft is cockpit voice recorder CVR and flight data recorder FDR together. The electronic FDR (accident data recorder) contains information about altitude, flight speed, fuel, turbulence, wind speed.

Equipped with an Underwater Locator Beacon ULB, FDR sends out a ping every second for 30 days and can be traced by SONAR up to depths of 14000 feet.

21. Radio Carbon Dating: This technique by Willard Libby uncovered the truth about the “Shroud of Turin” which believers claim once covered the body of Jesus Christ but was later shown to be from a period between 1260 and 1390. There has been a perturbation in the environmental levels of radio carbon over the past 60 years due to above-ground nuclear weapons testing. Since then they’ve been dropping back towards natural levels. Using this, forensic anthropologists have been able to study the **recent human remains** and find the year of birth (up to 1.5 years) and year of death (accurate up to 3 years) by measuring carbon-14 levels in tooth enamel and soft tissues (blood, nails and hair) respectively. Soft tissues get constantly made and remade during life so they mirror the radiocarbon levels of changing environment. The pupal cases of insects whose larvae feed on soft tissues store the radiocarbon content act as decay resistant proxy for the tissues yielding the year of death. The spike in C-14 atmospheric levels during 1950s and early 1960s makes this approach possible, so it has limited period of utility.

22. Bloodstain pattern analysis helps to draw inferences about the nature and timing of the crime like homicide and also in **crime scene reconstruction**, by using physics (fluid dynamics) and trigonometry. Blood is a shear- thinning, non-Newtonian fluid viscous than water with a property of spatter ie formation of unique droplets and patterns on interaction with a surface. Viscosity of blood decreases with increasing

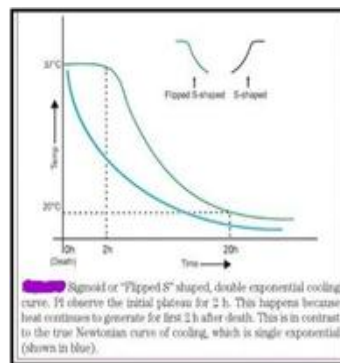
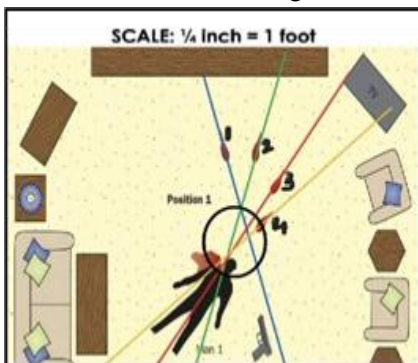

haematocrit and with higher shear. Adhesion property of blood form spines while cohesion property forms droplets. Recreating a crime scene of an apparent homicide involves the calculation of following: a)Area of convergence by drawing

a line through the spine of each of the droplets (encircled black in the figure) b) Angle of impact θ (in degrees) by taking arcsine of the ratio of width (W) of the stain to length(L) in mm and c) Tangent of angle of impact (in deg.) d) Distance from near edge of stain to centre of area of convergence (D) in

feet e) Find height of wound(H) in feet. A coroner uses **Newton’s law of cooling** to determine the time of death as “the rate at which an object cools α difference in temperature between the object and (T_s) temperature of its surroundings. $T - T_s = (T_0 - T_s)e^{-kt}$ where k is cooling constant, T is final temperature, T_0 is initial temperature of the body and t is time in seconds. Actually, Algor Mortis, has a double exponential cooling curve due to post mortem calorificity. A sample crime scene has been reconstructed as follows.

Stain	W	L	W/L	$\theta = \sin^{-1} W/L$	Tan θ (deg)	(D)	H = Tan $\theta \times D$
1	4.5	10.7	0.4205	25	0.4663	10.1	4.7
2	5.1	10.6	0.4811	29	0.5543	10.3	5.7
3	3.9	8.4	0.4642	28	0.5317	10.4	5.5
4	3.6	8.1	0.4444	26	0.4877	10.3	5
				Aver: 27		10.2	5.2

Accident reconstruction: Passengers not wearing seat belt get propelled and hurled into the air on collision of a fast moving car with a stationary object (Newton’s first law of motion- law of inertia). Newton’s third law implies conservation of total linear momentum. Change in

momentum of one colliding vehicle causes an equal and opposite change of momentum of the other vehicle-this principle helps in accident reconstruction. Skidding involves kinetic friction and skid marks specify pre-collision direction of vehicles. The speed of the vehicles post collision is estimated by knowing the coefficient of friction between tyres and the road, slope of the road and total distance of the skid. Skidding analysis applied to pre impact skid marks determines original speeds, in accordance with law of conservation of momentum. Greater mass of colliding vehicles implies greater force applied and a greater destruction. A vehicle leaves **Yaw marks** (Crossways striations) as it is speedily guided through a curve since the vehicle is accelerating towards the centre of the curve and not traveling in the direction the driver intended. This acceleration is due to friction ie side thrust between the tires and the road. Yaw marks (Critical speed scuff marks), left from a rolling tire while sliding laterally simultaneously, are indicative of vehicle losing traction while rounding a curve. Thinner tire marks and bigger arc radius indicates high speed of the vehicle. The critical velocity is related to the coefficient of friction and the radius of the bend as $V_{critical} = (\mu gr)^{1/2}$ where μ is the coefficient of friction and r is the radius of the bend given by $r = C^2/8M + M/2$ (C is the length of the chord drawn between any two points on the arc and M is the perpendicular distance from the centre of chord to the arc.

23 Falling injuries: “It’s not the fall that kills you; it’s the sudden stop at the end of it.” A person of mass (m) at a height (h) above the ground is subjected to gravitational force (g) and his/her potential energy (mgh) is converted into kinetic energy $= 1/2 mv^2$ during a freefall. Since $mgh = 1/2 mv^2$, the severity of the injuries depends on the velocity of impact (v) which is calculated using the formula $v = (2gh)^{1/2}$. A person hit by a falling object gets hurt due to the Impact force F of the object, which is defined as the work done (W) to move an object to a specific distance (d). The work done equals the kinetic energy of the falling body so $W = F \times d = 1/2 mv^2$. This implies $F = mv^2/2d$. Since Velocity of the body (v) = Displacement (d)/ time (t), we get $F = mv/2t$ (m is mass in kg, t is time in seconds, g is acceleration due to gravity 9.8 m/sec^2 , d is distance in meters, v is velocity of body in m/s and F is impact force in newtons.)

Conclusion: Herbert Leon MacDonnell, in his book, “The Evidence Never Lies” (1984) wrote “Physical evidence cannot be intimidated, it does not forget. It doesn’t get excited at the moment something is happening like people do. It sits there and waits to be detected, preserved, evaluated and explained.” Laws of Physics provide cutting edge methods for identification, individualization and evaluation of physical materials with evidentiary value. Albert Einstein rightly said, “Scientists investigate that which already is. Engineers create that which has never been.”

PHYSICS IN FORENSIC SCIENCE

Gajanan Patil

Secondary School & Jr. College, Bhilawadi. Maharashtra

Key words: Forensic Science, Crime, mass spectrometer, photoluminescence phenomenon, Software.

Abstract - Forensic Physics represents a specialized field within forensic science, focusing on the analysis and comparison of physical evidence by evaluating their distinct properties, such as density, refractive index, resistivity, temperature, luminescence, elasticity, and composition. It applies the principles of physics to assist in the investigation and legal resolution of both criminal and civil cases. Numerous instances exist where physics has played a crucial role in solving forensic cases. Key tools utilized in this domain include infrared spectrometers, polarizing microscopy, and software-based analysis techniques.

Introduction: The Tandoor murder case, which occurred on 2nd July 1995, involved the killing of Naina Sahni by her husband Sushil Sharma. During the investigation, it was revealed that on the night of the incident, Sushil found Naina talking to someone on the phone and drinking alcohol. He objected to this and was also unhappy about Naina's friendship with Matloob Karim. This led to an argument, during which Sushil shot Naina, resulting in her death. Subsequently, he sought assistance from a restaurant manager named Keshav Kumar to dispose of the body. They dismembered the body and attempted to burn it in a tandoor. Through DNA identification, the victim was ultimately identified, and the local police unraveled the entire conspiracy.

These cases illustrate the essential work performed by Forensic Science, which combines various basic sciences such as physics, chemistry, biology, computer science, and engineering. It applies these sciences to legal matters, providing valuable insights to investigators, such as how blood reached a particular spot, its intoxication status, and the identity of the blood's owner.

In the development of Forensic Science, notable figures have made significant contributions. Mathieu Orfila is recognized as the father of Forensic Toxicology, having published the first scientific treatise on detecting poisons and their effects on animals in 1814. Alphonse Bertillon devised the first scientific system of personal identification and Anthropometry. Francis Galton conducted pioneering studies on fingerprints and classification methodology. Dr. Leone Lattes devised a relatively simple procedure for determining blood group from dried blood stains, which was immediately applied to criminal investigations. Calvin Goddard developed the comparison microscope to determine whether a particular gun had fired a bullet. Albert S. Osborn established fundamental principles for examining Questioned Documents, writing the first significant text on the subject in 1910. Hans Gross wrote the first treatise describing the application of scientific disciplines to criminal investigation. Edmond Locard's formulated the principle of exchange, also known as Locard's principle

Need for Forensic Science: The demand for Forensic Science is consistently rising in all aspects of life because it employs a scientific approach to solve crimes, ensuring that the innocent are not unjustly denied justice and that criminals are brought to account. As crimes become more sophisticated today, Forensic Science is more crucial than ever. Even when a perpetrator intends to leave no traces of their presence at the scene, their nervousness during the crime inadvertently leaves behind numerous shreds of evidence that may not be immediately apparent. This principle is aptly

demonstrated by "Every contact leaves a trace," and we can observe similar traces in our daily lives whenever we go somewhere, either visibly or discreetly.

Therefore, for thorough investigations, the assistance of Forensic Science is indispensable. In ancient times, crimes also existed, but without the aid of developed sciences like Forensic Science, solving cases was much more challenging. An example of this can be seen in the story of the judgment of King Solomon, where two women claimed to be the mother of a child, and the case was decided solely based on wisdom, logic, eyewitness accounts, and other factors found at the crime scene. However, without advanced forensic techniques like DNA fingerprinting, it was challenging to determine the true culprit and the innocent.

Nowadays, with the knowledge of DNA fingerprinting and other forensic tools, cases can be more easily resolved. Forensic Science stands apart from traditional witnesses or eyewitnesses as it is grounded in scientific principles and methods, ensuring high reliability, reproducibility, and ease of understanding. It effectively connects the culprit with the crime, the victim, the scene, the weapon, and other pieces of evidence. Moreover, it is immune to human flaws like bias, emotions, memory lapses, perjury, and rationalization. Additionally, it offers verifiable results and analyzes all types of evidence efficiently and cost-effectively.

Forensic physics: It is the application of physics principles to address legal questions in court. It primarily involves studying the physical characteristics of evidence, such as density, birefringence, refraction, and optical properties. This field also includes the physical matching of various materials like glass, paint, clothing patterns, wood handles, and cords. Additionally, it examines tool marks, footprints, textile matching, and other aspects.

Recently, some physics departments have introduced courses on forensic physics. These courses cover topics relevant to forensic professionals, including road accident analysis, firearm and bullets profile analysis, fire, arson, explosion investigation, materials identification (e.g., fake jewelry), and software-based imaging methods for facial reconstruction. Another area of interest involves using Newton's laws, momentum conservation laws, and trigonometry for blood pattern analysis and understanding physics-related falls from heights resulting in serious injury or death. These applications inspire educators to work on physics with new forensic perspectives.

In India, the Physics Division in State and Central Forensic Science Laboratories (FSLs) deals comprehensively with various cases, from crime scene reconstruction to trace evidence analysis and voice examinations. For those aspiring to develop a career in forensic sciences, understanding the classification of physical sciences branches within forensic sciences is crucial. This article helps individuals plan their careers in forensic physics, which can be categorized into five fields: General Physics (including General and Forensic Engineering Physics), Reconstruction of Crime Scenes, Forensic Accident Analysis, Material Science, and Analog and Digital Electronics.

The Forensic Physics course covers fundamental physics, electronics, ballistics, trace analysis, accident reconstruction, photography elements, forensic engineering, analog and digital electronics, and the study of various instruments used in evidence investigation and analysis. Figure-1 illustrates the branches of forensic physics.

Tools and Techniques Used in Forensic Physics

Forensic laboratories with diverse capabilities typically organize their resources into specialized sections based on the types of physical evidence they examine. Certain sections necessitate specific

equipment, instrumentation, and trained personnel, while other sections may share common instruments.

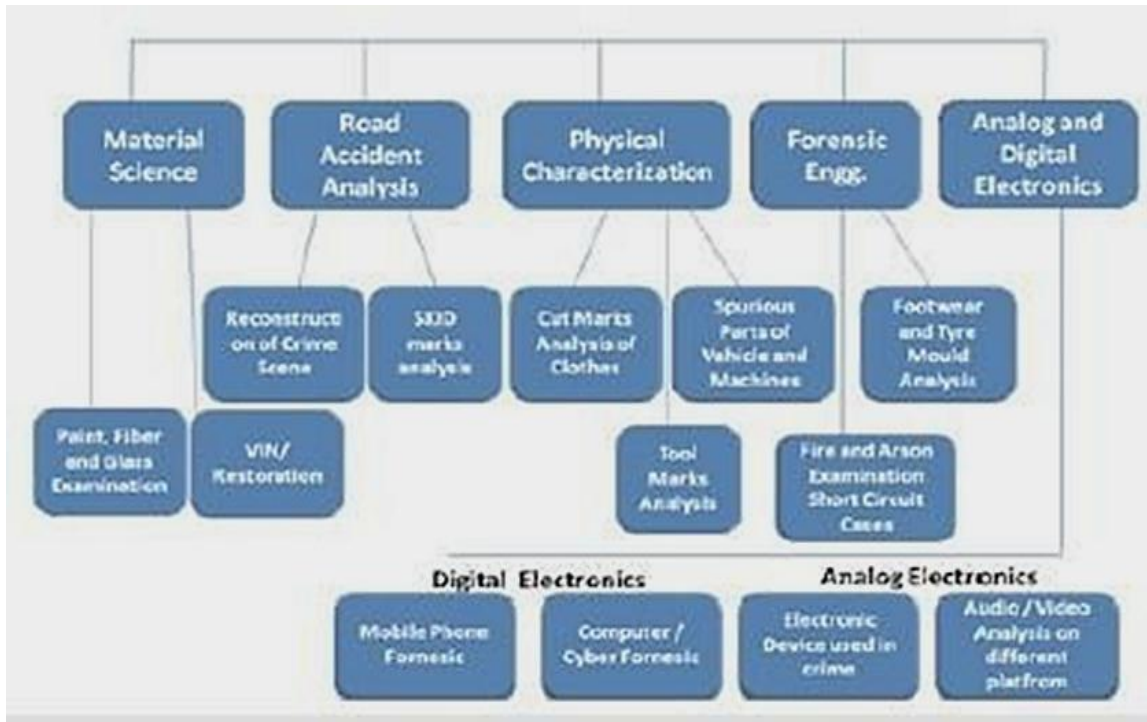

Figure 1 shows branches of Forensic physics

Video Spectral Comparator (VSC)

Ink comparison and differentiation are carried out by assessing the infrared reflection and luminescence properties present in the ink. This process is commonly achieved using a modern and sophisticated device called the Video Spectral Comparator (VSC). The VSC is an advanced instrument used in document examination, offering a non-destructive approach to scrutinizing documents through multiple instrumental parameters. It provides rapid and effortless results, making it a versatile tool for document analysis. The Video Spectral Comparator (VSC) is an imaging device that enables examiners to analyze inks, detect concealed security features, and uncover alterations in documents. It operates based on fundamental principles of light, using various light and filter configurations to provide superior capabilities compared to equipment with single light sources of different wavelengths. Being computer-compatible, it allows storing and retrieving case examination data as needed.

Equipped with specialized lighting tools, the VSC facilitates document examination under various conditions, such as visible, infrared, ultraviolet, transmitted, coaxial, and oblique lighting, either individually or in combination. This versatile instrument allows observing and recording documents or inks exposed to light of different wavelengths, facilitating analysis and comparison of inks to detect document alterations. Furthermore, it reveals visible security features incorporated into papers and enables swift examination of the entire questioned document.



Figure 2: Video Spectral Comparator (VSC)

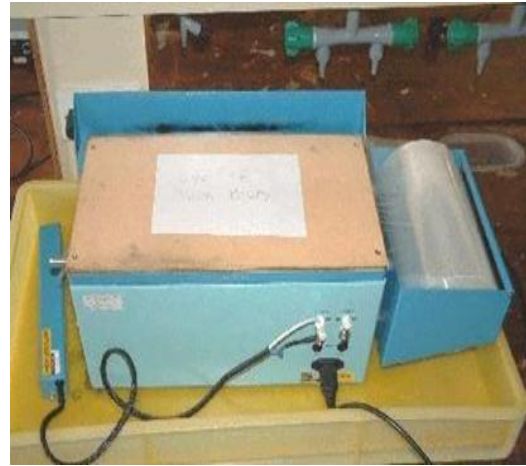

Figure 3: ESDA

Electrostatic Detection Apparatus (ESDA)

The Electro Static Discharge Apparatus, commonly known as ESDA, is a specialized instrument capable of revealing invisible handwritten impressions on paper. It is primarily used for detecting indented writing on documents, and it can also be employed to identify footwear impressions on paper items.

The ESDA is an electrostatic detection apparatus designed to decipher indented writings. When the paper's surface has indentations, it causes a distinct pattern of charging in those areas. This charge variation becomes visible by applying oppositely charged black toner powder. During the examination, the document is placed on the instrument and covered with a transparent film. The film and the document are then exposed to an electrostatic charge, causing the charge to dissipate rapidly, except in areas with indentations. In the final stage, black toner is applied to the film's surface, adhering to the charged parts and making the indented writing visible. This technique of examining documents for indented handwritten impressions can be valuable for various reasons. It provides a means to retrieve information from papers that may have been lost, destroyed, or are no longer accessible.

The stereoscopic Zoom microscope

The stereo microscope is an optical arrangement specially designed for observing samples at low magnifications. It typically utilizes reflected light from the surface of an object rather than transmitted light through it. This instrument employs two separate optical paths with two objectives and eyepieces, providing slightly different viewing angles to the left and right eyes. This setup creates a three-dimensional visualization of the sample under examination.

Stereomicroscopy is particularly useful for macro-photography, as it allows the examination of solid samples with intricate surface topography, requiring three-dimensional observation for detailed analysis. This technique finds widespread applications in industries for production, assessment, and quality control purposes. Additionally, the stereo microscope plays a crucial role in fields such as entomology and forensic ballistics. It is important to distinguish the stereo microscope from a compound microscope equipped with double eyepieces and a Bino viewer. In the compound microscope, both eyes observe the same image, which provides greater comfort during observation but does not offer a three-dimensional view like the stereomicroscope.



Figure- 4 Stereo Zoom Microscope



Figure- 5 Abbe's Refractometer

Refractometer: Glass is a commonly encountered physical evidence in various crimes, including housebreaking, traffic collisions, homicides, sexual assaults, gunfire incidents, arson, and vandalism. In forensic investigations, the examination of glass often involves comparing two or more glass fragments to ascertain whether they originate from distinct sources. Sometimes, the focus may be on determining the end use or the origin of the glass. Refractive index measurements are commonly employed in conducting glass examinations. Refractometers, whether used in laboratories or field settings, serve as devices to measure the index of refraction, aiding forensic experts in analyzing and comparing glass samples.

Scanning Electronic Microscope Commonly referred to as the SEM, the Scanning Electron Microscope is employed for observing specimen surfaces. By irradiating the specimen with a fine electron beam, secondary electrons are emitted from the surface. The surface's topography is then visualized through a two-dimensional scanning process of the electron beam across the specimen, and an image is generated from the detected secondary electrons.



Figure -6 Scanning Electronic Microscope

The Scanning Electron Microscope (SEM) necessitates an electron optical system to generate an electron probe, a specimen stage for placing the specimen, a secondary electron detector to collect secondary electrons, an image display unit, and an operation system for various functions. The electron optical system comprises an electron gun, a condenser lens, and an objective lens to create the electron probe, as well as a scanning coil and other components to scan the electron probe. These components are located within the microscope column, and the area around the specimen is maintained under vacuum conditions.

Sound Spectrograph: A spectrograph is an instrument designed to separate incoming light based on its wavelength and record the resulting spectrum using a detector. In the context of sound, a sound spectrograph serves as an automatic sound wave analyzer used for analyzing and classifying human speech sounds, as well as in the analysis and treatment of speech and hearing disorders. The analog sound spectrograph operates by sampling energy levels within a small frequency range from a magnetic tape recording and marking those levels on electrically sensitive paper.

The process involves the instrument analyzing the next small frequency range, sampling and marking the energy levels, and repeating this procedure until the entire desired frequency range is analyzed for that portion of the recording. The final result is known as a Spectrogram, which is a graphic representation of the patterns, represented as bars or formants, of the acoustical events occurring during the analyzed time frame.

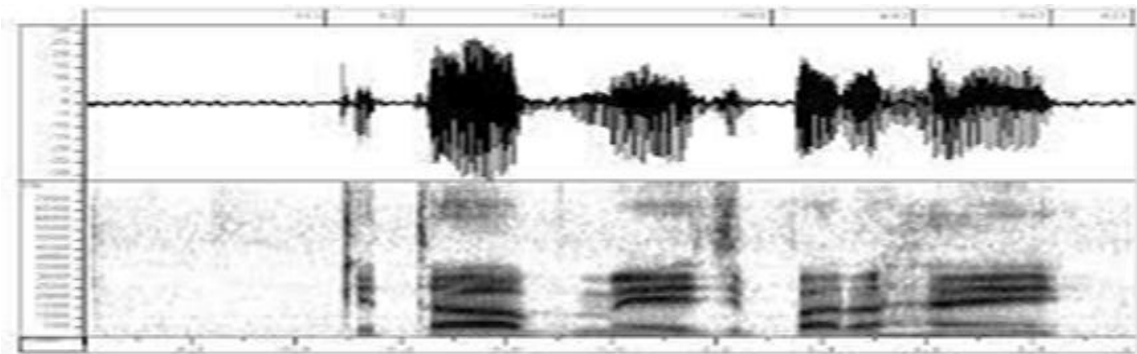

Figure-7 Sound Spectrograph

Integrated Ballistics Identification System (IBIS): The system is utilized for capturing, storing, and comparing digital images of projectiles and cartridge cases. This tool serves as a screening aid, enabling laboratories to identify potential links between firearms cases submitted for examination, whether they are local, national, or international in scope. Through the use of computers and an enhanced microscope, an operator can compare newly acquired evidence with previously recorded images. Digital images of projectiles and cartridge cases are taken and uploaded for comparison, as depicted in Figure-8.



Figure-8 Integrated Ballistics Identification System (IBIS)

Neutron activation analysis of GSR

Neutron Activation Analysis is a broad term used to describe the process of irradiating materials with neutrons to produce radionuclides. The discovery of Neutron Activation Analysis dates back to 1936 when Hevesy and Levi observed that samples containing specific rare earth elements became highly radioactive when exposed to neutrons. Based on this observation, they realized the potential of

inducing nuclear reactions in samples, leading to induced radioactivity, which could be used for both qualitative and quantitative identification of numerous elements. Figure 9 illustrates this process.

Comparison Microscope

The Comparison Microscope is a device utilized for analyzing side-by-side specimens. It consists of two microscopes connected by an optical bridge, resulting in a divided view window that allows two separate objects to be observed simultaneously. This instrument provides the observer with the capability to view both objects at the same level of magnification. It can be equipped with either a monocular or binocular eyepiece. Figure-10 illustrates the setup of a comparison microscope, which enables a simultaneous examination of two objects.



Figure -9 Neutron activation analysis Unit



Figure-10 Comparison Microscope

Poli Light Source: As depicted in Figure-11, this device consists of a powerful lamp that emits light containing ultraviolet, visible, and infrared components. The light is then filtered into separate colour bands, enhancing the visualization of evidence through light interface techniques such as fluorescence (evidence glowing), absorption (evidence darkening), and oblique lighting (exposing small particle evidence). The incorporation of fluorescent enhancement techniques, which complement the light source, significantly expands the range of planes from which latent fingerprints can be detected.



Figure-11

X-ray Fluorescence: The XRF technique is a non-destructive analytical method employed to ascertain the elemental composition of materials. It relies on the emission of characteristic X-ray radiation when a sample is exposed to exciting radiation from a higher-energy X-ray source. The resulting spectra are presented as intensity versus energy or wavelength.

Cases in India

According to the Indian Penal Code Cases updated up to 7 July 2023 in India are 110978 all over India. Crime heads and their quantity are given from 2016 to July 2023 in Table 1. Out of 110978 cases, using forensic physics solved cases are 68473. Thus, physics in forensic science plays an important

Sl. No	Crime Heads	2016	2017	2018	2019	2020	2021	2022 (Provisional)	2023 (Up to May)
1	Murder	305	305	292	323	306	337	319	131
2	Attempt to commit murder	622	583	672	729	610	600	709	390
3	CH not amounting to murder	132	112	90	93	84	78	82	37
4	Rape	1656	2003	2005	2023	1880	2339	2503	1078
5	Kidnapping & abduction	241	293	297	386	307	364	399	129
6	Dacoity	71	63	71	87	69	64	58	27
7	Robbery	908	807	867	741	610	780	840	357
8	Burglary	2579	2380	2389	2293	1619	1947	2265	1010
9	Theft	3936	3844	3651	3401	2418	3119	3924	1868
10	Riots	5089	4689	4236	3514	3520	1725	2066	536
11	Criminal breach of trust	274	220	289	204	120	182	155	76
12	Cheating	4623	3930	4643	6347	8993	5214	7791	4780
13	Counterfeiting	43	25	43	33	23	25	35	14
14	Arson	554	405	341	389	317	256	243	124
15	Hurt	17388	20323	20087	18910	16238	15579	15677	8243
16	Dowry Deaths(304(B) IPC)	25	12	17	8	6	9	8	5
17	Molestation	4029	4413	4544	4507	3890	4059	5354	2049
18	Sexual harassment	328	421	461	435	442	504	584	264
19	Cruelty by husband or relatives	3455	2856	2046	2970	2707	4997	5019	2018
20	Other IPC Crimes	213839	188162	139917	128417	104940	100465	189363	87842
Total cognizable crimes (IPC cases)		260097	235846	186958	175810	149099	142643	237394	110978

Table-1: Crime heads and their quantity (Courtesy of the Official website of Kerala Police)

role in solving the above cases. With the aid of different physical instruments and techniques solving the cases has become easier. Some computer software like Windows Scope, Xplico, The Sleuth Kit, Forensic Toolkit, etc. are useful for this.

Conclusion

Forensic science is experiencing rapid growth alongside an increase in crime rates in society. As a result, investigative agencies are increasingly turning to forensic science for its expertise in scientifically solving crimes that would otherwise be challenging to resolve. Through the application of forensic physics, it becomes possible to justly convict suspects and exonerate the innocent.

For forensic scientists to be effective, they must possess an awareness of various sources of information and a comprehensive understanding of diverse tools and techniques of Physics. This knowledge enables a deeper comprehension of the multifaceted aspects of forensic science and the role of physics in addressing the unique challenges of this field. Consequently, physics assumes a crucial role in advancing the study of forensic science.

References

1. Houck M M, Siegel JA (2010) Fundamentals of Forensic Science, (2nd edn), Academic Press, San Diego, USA.
2. Lewis P R, Reynolds K, Gagg C (2003) Forensic Materials Engineering: Case Studies, CRC Press, Boca Raton, Florida, USA.
3. Noon R K (2001) Forensic Engineering Investigation, CRC Press, Boca Raton, Florida, USA.
4. Li CT (2011) Computational Forensics, Digital Crime, and Investigation Yurchak Printing Inc, Hershey, USA.
5. Franck H, Franck D (2013) Forensic Engineering Fundamentals (1st edn), CRC Press, Boca Raton, Florida, USA.
6. Toni F (2009) Physicists in forensics. Physics Today 62(3): 20
7. <https://keralapolice.gov.in/crime-statistics/ipc-cases>
8. Gupta A.K. (2021),Forensic Science, Pathshala module tag 28, SGTB Khalasa College,New Delhi.
9. Devashish Bhoose,(2019) Introduction to Forensic Science, Dr. Harisingh Gour University, Sagar.

Appendix

Guidelines for Essay Writing and Developing Skills for Science Communication

Do you know that the word ‘essay’ is derived from a Latin word ‘*exagium*’, which roughly translates to presenting one’s case? Essay is often considered synonymous with a story or a paper or an article. Essays can be formal as well as informal. There are broadly four types of essays:

Descriptive Essays: Here the writer will describe a place, an object, an event or may be even a memory. But it is not just plainly describing things. The writer must paint a picture through his words.

Narrative Essays: This is when the writer is narrating an incident or story through the essay.

Expository Essays: In such an essay a writer presents a balanced study of a topic. To write such an essay, the writer must have real and extensive knowledge about the subject.

Persuasive Essays: Here the purpose of the essay is to get the reader to your side of the argument.

Format of an Essay

As such there is no rigid format of an essay. It is a creative process and should not be confined within rigid boundaries. However, there is a basic structure that is generally followed while writing essays. So, let us take a look at the general structure of an essay.

Introduction: This is the first paragraph of your essay. This is where the writer introduces his topic for the very first time. You can start with a quote or a proverb. Sometimes you can even start with a definition. Another interesting strategy to engage with your reader is to start with a question.

Body: This is the main crux of your essays. This need not be confined to one paragraph. It can extend to two or more paragraphs according to the content. Usually, we have a lot of information to provide in the body. Write the information in a systematic flow so that the reader can comprehend. So, for example, you were narrating an incident. The best manner to do this would be to go in a chronological order.

Conclusion: This is the last paragraph of the essay. Sometimes a conclusion will just mirror the introductory paragraph but make sure the words and syntax are different. Make sure you complete your essays with the conclusion, leave no hanging threads. In writing an essay on scientific topic, you have to ferret out interesting science themes/dimensions of the subject. Observation, exploration and investigation-things around you and activities you witness on a daily basis. For example if you are mentioning population you may also mention population density (an idea similar to surface charge density) or when mentioning power you may have a graph showing how it has grown over the decades. As a keen scientist you need to share your observations, exploration and investigation. If you are mentioning pollution of air then mention AQI, you should mention also the vehicle density. Further, you may have a graph showing how the number of vehicles has grown over the decades. Data presented in such an essay particularly in visual format through graphs, diagrams, flowcharts, pictures etc. can add a lot to the comprehension of your article. It is a good idea to do a survey of literature to gather facts. You should never involve in cut and paste act; it is plagiarism and is unethical. Acknowledge the sources in the end by giving a comprehensive bibliography. It is a joy to be part of this process of writing, where one acquires a skill which can become a strong part of the profile of the author and maybe launch him as a science journalist.